

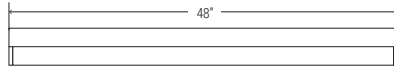

MULTI-LUMEN  
SELECTOR

EASY 3 COLORS  
**SELECTOR**  
3500K • 4000K • 5000K

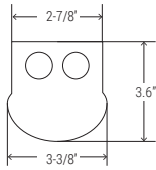

NOMINAL LUMENS	DELIVERED LUMENS	WATTAGE
5000	5546	36W
4000	4265	28W
3000	3231	21W
6000	6278	46W
7000	7397	56W
8000	8038	63W

Based on 4000K, 85+ CRI. Actual wattage may vary +/- 5%

**FEATURES**

The OEC is a versatile LED strip light that can be suspended or surface mounted. Available in single pendant or continuous mounting with a form factor that ensures continuous illumination. An acrylic lens delivers low-glare, even illumination for comfortable environments. The slim 3-3/8" profile makes the OEC ideal for illuminating a variety of narrow applications such as aisles, hallways, corridors, parking garages, as well as education, healthcare, and transportation applications.

LUMENS	3000/4000/5000 6000/7000/8000
CCT	35K/40K/50K
CRI	85+
COLOR QUALITY	3 Step MacAdam Ellipse
LENGTH	2', 4' or 8'
MOUNTING	Suspended or Surface
DIMMING & CONTROL	0-10V Flicker Free 10% Dimming Standard (DIM10)
EMERGENCY	10W - Up to 1480L output
LIFETIME	L70 at 50,000 Hours
PHOTOMETRIC TESTS	In Accordance with IES LM79-08, LM80 and TM-30, TM-21



**OPTICS & PERFORMANCE**

Frosted acrylic lens provides even, shadow-free illumination. Lens has tool-less removal, ensuring easy upgrading and maintenance.

**CONSTRUCTION**

Heavy-duty 20-gauge cold rolled steel body, post-painted. High-gloss white finish is pre-treated with 5-stage iron phosphate coating, which provides superior paint adhesion and protection against weathering.

**INSTALLATION**

Surface or suspended mounting; individual or continuous row mounting (CRM). The first luminaire in the row for CRM will always be the power supply feed. After plugging in the male and female harnesses, which are supplied with each luminaire, they will easily slide together. Secure with two screws in the connecting brackets.

**DRIVER ELECTRICAL INFORMATION**

Powered by high-quality constant-current power LED drivers, rated for 50 to 60Hz at 120-277V input, produce less than 20% THD, and have a power factor of .90 to 1.00. Male and female 18-gauge 6 wire plug connectors are included with every luminaire to allow for simple, hassle-free continuous wiring. Each luminaire must be installed male to female.

**MULTI LUMEN/MULTI CCT**

Easily field-selectable multi-lumen and multi-CCT selector switches allow you to easily change the intensity and CCT in the field.

**DIMMING & DRIVER INFORMATION**

**DIM10** - Flicker Free 10% Dimming Standard (DIM10) 0-10V dimming on either MVOLT 120, 277V.

**WARRANTY**

Five-year warranty for parts and components. (Labor not included)

**LISTINGS**

c-UL-us - Listed for Feed Through Wiring.  
c-UL-us - Listed for Damp Location.  
Listed for DLC, California Title 24 compliant.

Suitable for use in closet storage spaces when installed in accordance with NFPA-70 and NEC 410.16 spacing requirements

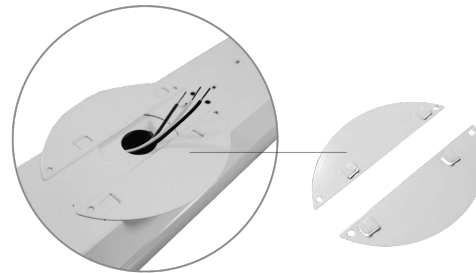

Cover for junction box is shipped standard with fixture, along with necessary hardware to secure cover to j-box.

Example: **4-OEC-LED-3000L/4000L/5000L-DIM10-MVOLT-35K/40K/50K-85**

4	OEC	LED								
FIXTURE SIZE	SERIES	TYPE	LUMENS	DIMMING	VOLTAGE	CCT	CRI	EMERGENCY	MOUNTING	
4 - 4'	OEC - LED General Linear	LED	3000L/4000L/5000L 6000L/7000L/8000L	DIM10 - 0-10V Dimming	MVOLT	35K/40K/50K 30K*	85	0-EMG-LED-10W	CRM - Continuous Row Mounting	
*only for 3000/4000/5000										
<b>OTHER OPTIONS</b>										
<b>OCGSS</b> - Cable Gripper Suspension Kit <b>4-OCN-T8-WG-WH</b> - WireGuard-White <b>4-OCN-T8-WG-AL</b> - WireGuard-Aluminum <b>S05</b> - Power cord with 5 conductors for 0-10v dimming fixtures <b>S06</b> - Power cord with 6 conductors for 0-10V dimming and with emergency <b>VHCH</b> - V-Hook & chain <b>MFG-BRACKET-CR-OEC</b> - bracket for continuous row mounting										
<b>SIDE MOUNT</b>										
<b>OSFHU-LTW</b> ON/OFF Line Voltage <b>HB011-PDX</b> Occupancy Sensor with 0-10V Dimming <b>FSP-311-B-D</b> 0-10V continuous dimming PIR photo/motion sensor with bluetooth control option. <b>411-HBOLA-PDX</b> 0-10v Dimming Sensor with Day Light harvesting PIR technology.option.										

**4-OEC-LED-3000L-4000L-5000L-DIM10-MVOLT-35K-40K-50K-85(5000L).**

TEST NO.: **EL122719102**

INPUT WATTS: **36.5**

LUMENS: **5546**

CRI: **85**

EFFICACY: **152**

CCT: **4000K**

SPACING CRITERIA: **1.40**

**Candle Power Distribution (Candelas)**

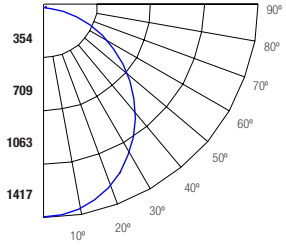

**Zonal Lumens Summary**

Zone	Lumens	%Lamp	%Fixt
0-20	517.16	9.3	9.3
0-30	1100.39	19.9	19.8
0-40	1810.82	32.7	32.7
0-60	3291.15	59.4	59.3
0-80	4415.41	79.7	79.6
0-90	4773.18	86.1	86.1

**Luminance (Average candela/M<sup>2</sup>)**

Angle in Degrees	Average 0°	Average 45°	Average 90°
45	10065	11552	12655
55	9398	11873	13590
65	8533	12869	15500
75	7347	16081	20506
85	5350	35601	47645

**Lumens Per Zone**

Zone	Lumens
0-10	133.77
10-20	383.39
20-30	583.23
30-40	710.43
40-50	755.81
50-60	724.52
60-70	629.26
70-80	495
80-90	357.77

**Candela Tabulation**

0	
0	1417.3
5	1409.5
15	1349.3
25	1232
35	1068.9
45	873.63
55	661.63
65	442.63
75	233.42
85	57.239
90	12.632

**Coefficients of Utilization - Zonal Cavity Method**

Effective Floor Cavity Reflectance 0.20

RC	RW	80%				70%				50%			30%			10%			0%			
		70%	50%	30%	10%	70%	50%	30%	10%	50%	30%	10%	50%	30%	10%	50%	30%	10%	50%	30%	10%	
0	116	116	116	116	116	112	112	112	112	103	103	103	96	96	96	89	89	89	86	86	86	86
1	103	97	92	88	88	99	94	89	85	87	83	80	81	78	75	75	72	70	67	67	67	67
2	93	84	76	70	70	89	81	74	68	75	69	64	69	65	61	64	61	57	54	54	54	54
3	84	73	64	57	57	81	70	62	56	65	58	53	61	55	50	56	52	48	45	45	45	45
4	77	64	55	48	48	73	62	53	47	58	50	45	54	47	42	50	45	40	38	38	38	38
5	71	57	48	41	41	67	55	46	40	51	44	38	48	42	36	45	39	35	32	32	32	32
6	65	51	42	35	35	62	50	41	35	46	39	33	43	37	32	40	35	30	28	28	28	28
7	60	46	37	31	31	58	45	36	30	42	35	29	39	33	28	37	31	27	25	25	25	25
8	56	42	33	27	27	54	41	33	27	38	31	26	36	30	25	34	28	24	22	22	22	22
9	52	39	30	25	25	50	37	30	24	35	28	23	33	27	22	31	26	22	20	20	20	20
10	49	35	27	22	22	47	34	27	22	33	26	21	31	25	20	29	24	20	18	18	18	18

RC - Ceiling Cavity Reflectance

**4-OEC-LED-3000L-4000L-5000L-DIM10-MVOLT-35K-40K-50K-85(4000L).**

TEST NO.: **EL122719101**

INPUT WATTS: **28**

LUMENS: **4265**

CRI: **85**

EFFICACY: **152**

CCT: **4000K**

SPACING CRITERIA: **1.40**

**Candle Power Distribution (Candelas)**

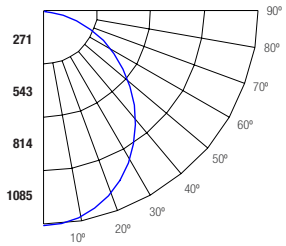

**Zonal Lumens Summary**

Zone	Lumens	%Lamp	%Fixt
0-20	396.7	9.3	9.3
0-30	844.25	19.8	19.8
0-40	1391.68	32.7	32.6
0-60	2533.23	59.4	59.4
0-80	3396.98	79.7	79.6
0-90	3672.13	86.2	86.1

**Luminance (Average candela/M<sup>2</sup>)**

Angle in Degrees	Average 0°	Average 45°	Average 90°
45	7719	8846	9704
55	7218	9084	10417
65	6649	9834	11888
75	5646	12406	15745
85	4086	27155	36990

**Lumens Per Zone**

Zone	Lumens
0-10	102.61
10-20	294.09
20-30	447.55
30-40	547.43
40-50	584
50-60	557.55
60-70	483.07
70-80	380.69
80-90	275.15

**Candela Tabulation**

0	
0	1085.4
5	1079.7
15	1033
25	944.05
35	819.14
45	670
55	508.18
65	344.93
75	179.36
85	43.712
90	8.793

**Coefficients of Utilization - Zonal Cavity Method**

Effective Floor Cavity Reflectance 0.20

RC	RW	80%				70%				50%			30%			10%			0%			
		70%	50%	30%	10%	70%	50%	30%	10%	50%	30%	10%	50%	30%	10%	50%	30%	10%	50%	30%	10%	
0	116	116	116	116	116	112	112	112	112	103	103	103	96	96	96	89	89	89	86	86	86	86
1	103	97	92	88	88	99	94	89	85	87	83	80	81	78	75	75	72	70	67	67	67	67
2	93	84	76	70	70	89	81	74	68	75	69	64	69	65	61	64	61	57	54	54	54	54
3	84	73	64	57	57	81	70	62	56	65	58	53	61	55	50	56	52	48	45	45	45	45
4	77	64	55	48	48	73	62	53	47	58	50	45	54	47	42	50	45	40	38	38	38	38
5	71	57	48	41	41	67	55	46	40	51	44	38	48	42	36	45	39	35	32	32	32	32
6	65	51	42	35	35	62	50	41	35	46	39	33	43	37	32	40	35	30	28	28	28	28
7	60	46	37	31	31	58	45	36	30	42	35	29	39	33	28	37	31	27	25	25	25	25
8	56	42	33	27	27	54	41	33	27	38	31	26	36	30	25	34	28	24	22	22	22	22
9	52	39	30	25	25	50	37	30	24	35	28	23	33	27	22	31	26	22	20	20	20	20
10	49	35	27	22	22	47	34	27	22	33	26	21	31	25	20	29	24	20	18	18	18	18

RC - Ceiling Cavity Reflectance

**4-OEC-LED-3000L-4000L-5000L-DIM10-MVOLT-35K-40K-50K-85(3000L).**

TEST NO.: **EL12271999**

INPUT WATTS: **21**

LUMENS: **3277**

CRI: **85**

EFFICACY: **158**

CCT: **3500K**

SPACING CRITERIA: **1.40**

**Candle Power Distribution (Candelas)**

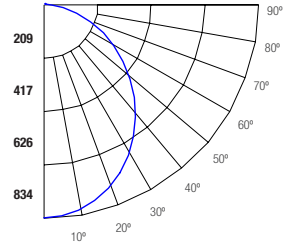

**Zonal Lumens Summary**

Zone	Lumens	%Lamp	%Fixt
0-20	305.21	9.3	9.3
0-30	649.57	19.8	19.8
0-40	1069.22	32.7	32.6
0-60	1941.67	59.3	59.3
0-80	2602.34	79.5	79.4
0-90	2813.15	85.9	85.9

**Luminance (Average candela/M<sup>2</sup>)**

Angle in Degrees	Average 0°	Average 45°	Average 90°
45	7468	6685	5889
55	8022	6802	5498
65	9158	7271	5007
75	12129	8935	4287
85	28233	19119	3299

**Lumens Per Zone**

Zone	Lumens
0-10	78.92
10-20	226.29
20-30	344.36
30-40	419.65
40-50	446.19
50-60	426.26
60-70	369.51
70-80	291.17
80-90	210.81

**Candela Tabulation**

0	
0	834.436
5	834.27
15	815.38
25	776.62
35	720.04
45	648.21
55	564.8
65	475.07
75	385.32
85	302.04
90	264.29

**Coefficients of Utilization - Zonal Cavity Method**

Effective Floor Cavity Reflectance 0.20

RC	RW	80%				70%				50%			30%			10%			0%			
		70%	50%	30%	10%	70%	50%	30%	10%	50%	30%	10%	50%	30%	10%	50%	30%	10%	50%	30%	10%	
0	116	116	116	116	116	111	111	111	111	103	103	103	96	96	96	89	89	89	86	86	86	86
1	103	97	92	88	88	99	94	89	85	87	83	80	80	77	75	75	72	70	67	67	67	67
2	93	84	76	70	70	89	81	74	68	75	69	64	69	65	60	64	60	57	54	54	54	54
3	84	73	64	57	57	81	70	62	56	65	58	53	60	55	50	56	51	48	45	45	45	45
4	77	64	55	48	48	73	62	53	47	58	50	45	54	47	42	50	45	40	38	38	38	38
5	71</																					

**4-OEC-LED-6000L-7000L-8000L-DIM10-MVOLT-35K-40K-50K-85(6000L)**

TEST NO.: **EL12282061**

INPUT WATTS: **46.4**

LUMENS: **6278**

CRI: **85**

EFFICACY: **135**

CCT: **3500K**

SPACING CRITERIA: **1.40**

**Candle Power Distribution (Candelas)**

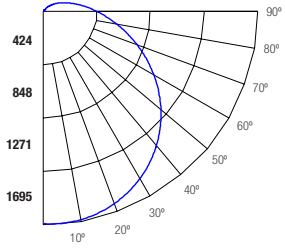

**Zonal Lumens Summary**

Zone	Lumens	%Lamp	%Fixt
0-20	611.68	9.70	9.70
0-30	1298.34	20.70	20.70
0-40	2128.87	33.90	33.90
0-60	3826.16	60.90	60.90
0-80	5077.92	80.90	80.90
0-90	5470.39	87.10	87.10

**Luminance (Average candela/M<sup>2</sup>)**

Angle in Degrees	Average		
	0°	45°	90°
45	14764	17947	20094
55	13320	18321	21364
65	11628	19672	23871
75	9535	24309	30542
85	6173	52609	68407

**Lumens Per Zone**

Zone	Lumens
0-10	158.44
10-20	453.24
20-30	686.66
30-40	830.53
40-50	873.12
50-60	824.17
60-70	704.50
70-80	547.26
80-90	392.47

**Candela Tabulation**

0	
0.0	1676.219
5.0	1669.210
15.0	1584.850
25.0	1430.150
35.0	1218.950
45.0	970.820
55.0	710.430
65.0	456.990
75.0	229.480
85.0	50.030
90.0	10.510

**Coefficients of Utilization - Zonal Cavity Method**

Effective Floor Cavity Reflectance 0.20

RC	RW	80%				70%				50%			30%			10%			0%	
		70%	50%	30%	10%	70%	50%	30%	10%	50%	30%	10%	50%	30%	10%	50%	30%	10%	0%	0%
0	116	116	116	116	116	112	112	112	112	104	104	104	97	97	97	90	90	90	87	87
1	104	98	93	88	88	99	94	90	86	88	84	80	81	78	76	76	73	71	68	68
2	93	84	77	70	70	89	81	74	68	76	70	65	70	66	62	65	62	58	55	55
3	85	73	65	58	58	81	71	63	56	66	59	54	61	56	51	57	53	49	46	46
4	77	65	55	48	48	74	63	54	47	58	51	45	54	48	43	51	46	41	39	39
5	71	58	48	41	41	68	56	47	41	52	45	39	49	42	37	46	40	36	33	33
6	65	52	43	36	36	63	50	41	35	47	39	34	44	38	33	41	36	31	29	29
7	61	47	38	32	32	58	45	37	31	43	35	30	40	34	29	38	32	28	25	25
8	56	43	34	28	28	54	41	33	28	39	32	27	37	30	26	35	29	25	23	23
9	53	39	31	25	25	50	38	30	25	36	29	24	34	28	23	32	26	22	20	20
10	49	36	28	23	23	47	35	27	22	33	26	22	31	25	21	30	24	20	18	18

RC - Ceiling Cavity Reflectance

**4-OEC-LED-6000L-7000L-8000L-DIM10-MVOLT-35K-40K-50K-85(7000L)**

TEST NO.: **EL12282062**

INPUT WATTS: **56.5**

LUMENS: **7397**

CRI: **85**

EFFICACY: **131**

CCT: **3500K**

SPACING CRITERIA: **1.40**

**Candle Power Distribution (Candelas)**

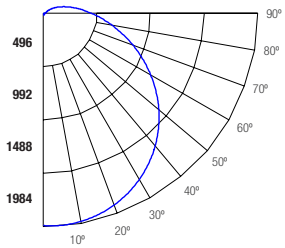

**Zonal Lumens Summary**

Zone	Lumens	%Lamp	%Fixt
0-20	721.10	9.70	9.70
0-30	1530.6	20.70	20.70
0-40	2509.75	33.90	33.90
0-60	4508.43	61.00	61.00
0-80	5981.21	80.90	80.90
0-90	6443.48	87.10	87.10

**Luminance (Average candela/M<sup>2</sup>)**

Angle in Degrees	Average		
	0°	45°	90°
45	17352	21149	23708
55	15664	21572	25217
65	13681	23180	28172
75	11188	28658	36100
85	7263	62019	80766

**Lumens Per Zone**

Zone	Lumens
0-10	186.78
10-20	534.32
20-30	809.50
30-40	979.15
40-50	1029.14
50-60	969.53
60-70	827.99
70-80	644.80
80-90	462.27

**Candela Tabulation**

0	
0.0	1975.79
5.0	1962.81
15.0	1863.84
25.0	1681.95
35.0	1433.20
45.0	1140.96
55.0	835.46
65.0	537.65
75.0	269.27
85.0	58.86
90.0	12.30

**Coefficients of Utilization - Zonal Cavity Method**

Effective Floor Cavity Reflectance 0.20

RC	RW	80%				70%				50%			30%			10%			0%	
		70%	50%	30%	10%	70%	50%	30%	10%	50%	30%	10%	50%	30%	10%	50%	30%	10%	0%	0%
0	116	116	116	116	116	112	112	112	112	104	104	104	97	97	97	90	90	90	87	87
1	104	98	93	88	88	99	94	90	86	88	84	80	81	78	76	76	73	71	68	68
2	93	84	77	70	70	89	81	74	68	76	70	65	70	66	62	65	62	58	55	55
3	85	73	65	58	58	81	71	63	56	66	59	54	61	56	51	57	53	49	46	46
4	77	65	55	48	48	74	63	54	47	58	51	45	54	48	43	51	46	41	39	39
5	71	58	48	41	41	68	56	47	41	52	45	39	49	42	37	46	40	36	33	33
6	65	52	43	36	36	63	50	41	35	47	39	34	44	38	33	41	36	31	29	29
7	61	47	38	32	32	58	45	37	31	43	35	30	40	34	29	38	32	28	25	25
8	56	43	34	28	28	54	41	33	28	39	32	27	37	30	26	35	29	25	23	23
9	53	39	31	25	25	51	38	30	25	36	29	24	34	28	23	32	26	22	20	20
10	49	36	28	23	23	47	35	27	22	33	26	22	31	25	21	30	24	20	18	18

RC - Ceiling Cavity Reflectance

RW - Wall Reflectance

**4-OEC-LED-6000L-7000L-8000L-DIM10-MVOLT-35K-40K-50K-85(8000L)**

TEST NO.: **EL12282063**

INPUT WATTS: **63.1**

LUMENS: **8038**

CRI: **85**

EFFICACY: **127**

CCT: **3500K**

SPACING CRITERIA: **1.40**

**Candle Power Distribution (Candelas)**

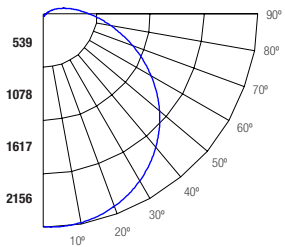

**Zonal Lumens Summary**

Zone	Lumens	%Lamp	%Fixt
0-20	784.09	9.80	9.80
0-30	1664.28	20.70	20.70
0-40	2728.88	33.90	33.90
0-60	4901.04	61.00	61.00
0-80	6500.63	80.90	80.90
0-90	7002.91	87.10	87.10

**Luminance (Average candela/M<sup>2</sup>)**

Angle in Degrees	Average		
	0°	45°	90°
45	18859	22974	25782
55	17032	23465	27397
65	14860	25194	30642
75	12151	31121	39262
85	7875	67431	87798

**Lumens Per Zone**

Zone	Lumens
0-10	203.08
10-20	581.01
20-30	880.19
30-40	1064.61
40-50	1118.93
50-60	1053.23
60-70	899.67
70-80	699.92
80-90	502.29

**Candela Tabulation**

0	
0.0	2148.161
5.0	2133.990
15.0	2027.090
25.0	1828.680
35.0	1558.220
45.0	1240.040
55.0	908.430
65.0	583.990
75.0	292.450
85.0	63.820
90.0	13.280

**Coefficients of Utilization - Zonal Cavity Method**

Effective Floor Cavity Reflectance 0.20

RC	RW	80%				70%				50%			30%			10%			0%	
		70%	50%	30%	10%	70%	50%	30%	10%	50%	30%	10%	50%	30%	10%	50%	30%	10%	0%	0%
0	116	116	116	116	116	112	112	112	112	104	104	104	97	97	97	90	90	90	87	87
1	104	98	93	88	88	99	94	90	86	88	84	80	81	78	76	76	73	71	68	68
2	93	84	77	70	70	89	81	74	68	76	70	65	70	66	62	65	62	58	55	55
3	85	73	65	58	58	81	71	63	56	66	59	54	61	56	51	57	53	49	46	46
4	77	65	55	48	48	74	63	54	47	58	51	45	54	48	43	51	46	41	39	39
5	71	58	48	41	41	68	56	47	41	52	45	39	49	42	37	46	40	36	33	33
6</																				



**INTEGRATED SENSOR AND CONTROL OPTIONS**

With the integration of controls, Elite Lighting now offers its products with controls-ready performance that increases energy efficiency, smarter space planning, and the enhancement of safety and productivity in the workplace. By utilizing these controls, Elite Lighting luminaires enable your customer's facility to run smarter, with the use of an easily controlled system through any platform.

Luminaire will be shipped with Powerpacks pre-installed, ready to be integrated to designated control systems

Luminaire will be shipped with Sensors installed on the luminaire, allowing for individual luminaire control. Luminaires will be ready to be integrated with designated control systems

Luminaire will be shipped with Sensors to be remotely installed on the ceiling. Luminaires will be ready to be integrated with designated control systems

<b>BRAND</b>	
<b>PIR INTEGRATED SENSOR</b>	<input type="checkbox"/> FSP-311-B-D 0-10V continuous dimming PIR photo/motion sensor with bluetooth control option.

**SIDE MOUNT**

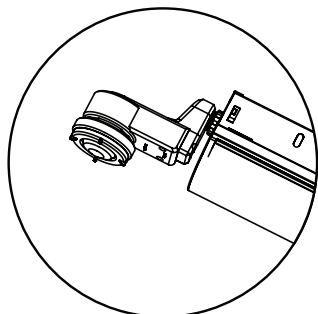

**LEGRAND**

FSP-311-B-D  
 0-10V continuous dimming PIR photo/motion sensor with bluetooth control option.