



LED WATTAGE CHART

	16L	32L	48L	64L
350 milliamps		33w	51w	66w
400 milliamps	21w			
530 milliamps	28w	54w	80w	102w
700 milliamps	36w	71w	104w	-

How can an outdoor luminaire possibly deserve the name "Legacy," which features breakthrough Lighting technology? The answer is simple. There are at least three distinct reasons; Performance, design and function.

The Legacy is the perfect luminaire designed to replace existing post top fixtures saving seventy five percent energy while meeting IES minimum foot candle levels and improving light distribution and uniformity.

The Full Cutoff Legacy luminaire features LEDs recessed deep into the luminaire eliminating any direct glare. The Legacy also features a clear tempered safety glass lens with silicone gasket which improves fixture reliability.

Legacy is available from 21 to 104 watts and its scale is perfect to replace any wattage between 70-400 watt HID. The Legacy throws light four to five mounting heights in all directions which is a major improvement of existing optical technology. The Legacy features the Star Power Reflector system, a diffused 95 percent reflective low glare optical material.

Legacy is available in Kelvin temperatures of 3000K, 3500K, 4000K and 5000K in both Type 3 and 5 light distributions.

BUY AMERICAN

To ensure the latest BAA/TAA/BABA Standards are being met, please select BAA, TAA, or BABA in the options section. Please contact the factory before placing an order for any NLS products requesting BAA (Buy American Act), TAA (Trade American Act), or BABA (Build America, Buy America).





STAR POWER™ OPTICAL SYSTEM

The Star Power™ reflector is an excellent system which provides great value and performance. Star Power Patent number: 10168023

Project Name:

Type:

LEGACY ORDERING GUIDE

Cat#	Light Dist.	# of LEDs	Miliamps	Kelvin	Volts
Legacy (LEG-1)	Type 3 (T3)	16 (16L)	350 (35) ³	Amber 586-600nM (AMBER) ^{5, 7, 10}	120-277 (UNV)
	Type 5 (T5)	32 (32L)	400 (40)	Amber LED Phosphor Converted (AMBER/PC) ^{7, 10}	347-480 (HV)
		48 (48L)	530 (53)	2700K, 70 CRI (27K7)	
		64 (64L)	700 (7)	2700K, 80 CRI (27K8) ¹	
				3000K, 70 CRI (30K7)	
				3000K, 80 CRI (30K8) ¹	
				3500K, 80 CRI (35K8) ¹	
				4000K, 70 CRI (40K7)	
				4000K, 80 CRI (40K8) ¹	
				5000K, 70 CRI (50K7)	
				5000K, 80 CRI (50K8) ¹	
Mounting	Color	# of Bars	Controls Options	Options	
Post Top Over 2-3/8" OD (PT2)	Bronze Textured (BRZ)	2 Bar (2B)	Custom Controls Integration (CCI) ⁴	Marine Grade Finish (MGF)	
Post Top Over 3" OD (PT3)	White Textured (WHT)		Button Type Photocell (PC) ²	House Side Shield (HSS)	
Post Top Over 3.5" OD (PT35)	Smooth White Gloss (SWT)	3 Bar (3B)	FSP-211 with Motion Sensor/Photocell 8' and Below Heights (FSP211-8) ^{2, 8}	Front Side Shield (FSS)	
Post Top Over 4" OD (PT4)	Silver Metallic (SVR)		9'-20' Heights (FSP211-20) ^{2, 8}	Buy American Act (BAA) ⁶	
Post Top Over 4" OD (PT4)	Black Textured (BLK)		FSP Remote (FSIR) ⁹	Trade Agreement Act (TAA) ⁶	
Mast Arm Fitter (MAF)	Smooth Black Gloss (SBK)			Build America Buy American (BABA) ⁶	
	Graphite Textured (GPH)				
	Grey Textured (GRY)				
	Green Textured (GRN)				
	Hunter Green Textured (HGN)				
	Custom (CS)				

NOTES:

1. Consult Factory for Lead Time. Consult Factory for 90 CRI Requests.
2. Universal Voltage 120-277
3. Only available in 16L
4. Please contact Factory for Custom Control Integration requests (nLight, NX, WaveLinx, Crestron, DMX/RDM, Synapse, Casambi, Dali II, Avi-On, or other control systems)
5. Turtle Safe
6. Consult factory for all BAA/TAA/BABA requests
7. Consult Factory for Lead Time
8. FSP-211, 120V/277V, 230-240VAC (single phase), 50/60Hz
9. Projects with sensors require Qty. 1 FSIR per project
10. Not available over 530mA



701 Kingshill Place, Carson, CA 90746
Call Us Today (310) 341-2037

nlsighting.com

PRODUCT SPECIFICATIONS

ELECTRICAL

- 120-277 Volts (UNV) or 347-480 Volts (HV)
- 0-10V dimming driver
- Driver power factor at maximum load is $\geq .95$, THD maximum load is 15%
- LED Drivers Ambient Temp. Min is -40°C and Ambient Temp. Max ranges from 50°C to 55°C and, in some cases, even higher. Consult the factory for revalidation by providing the fixture catalog string before quoting and specifying it.
- All internal wiring UL certified for 600 VAC and 105°C
- CRI 70, 80 or 90
- Color temperatures: Amber, 2700, 3000K, 3500K, 4000K, 5000K
- Surge Protection: 20KA supplied as standard.

CONSTRUCTION

- Cast Aluminum

OPTIONS

- MARINE GRADE FINISH (MGF) - A multi-step process creating protective finishing coat against harsh environments. Chemically washed in a 5 stage cleaning system. Pre-baked, Powder coated 3-5 mils of Zinc Rich Super Durable Polyester Primer. Oven Baked. Finished Powder Coating of Super Durable Polyester Powder Coat 3-5 mil thickness.
- SHIELDS (HSS, FSS) - Four-sided House Side Shield (HSS) is designed for full property line cut-off. Front-Side Shield (FSS) is a single-sided shield allowing partial cut-off on either side or front of luminaire.

CONTROL OPTIONS

- **FSP-211 w/Motion Sensor/Photocell (120/277VAC, 230-240VAC)**
(FSP-X) - Passive infrared (PIR) sensor providing multi-level control based on motion/daylight contribution.
- **FSP-221 w/Motion Sensor/Photocell (100-347VAC, 208/230/480VAC)**
(FSP-HV-X) - Passive infrared (PIR) sensor providing multi-level control based on motion/daylight contribution.
 - All control parameters adjustable via wireless configuration remote storing and transmitting sensor profiles.
 - FSP-8 mounting heights 8 feet and below.
 - FSP-20 mounting heights 9-20 feet.
 - FSP-40 mounting heights 21-40 feet.
 - Can maintain constant foot candles over time. Consult Factory
 - Includes 5 dimming event cycles, 0-10V dimming with motion sensing, re-programmable in the field.
 - FSIR-100 commissioning remote is required to change sensor settings. Please contact factory for ordering.
- PHOTOCCELL - Button type photocell.
- Controls Agnostic: Please contact factory for your preferred controls option. (nLight, NX, WaveLinx, Crestron, DMX/RDM, Synapse, Casambi, DALI II, Avi-On, or other control systems)

OPTICS

Recessed Star Power Optical System is 95% reflective material. Utilizes a linear diffused pattern, softening the light distribution and eliminating any dark shadows or striations.

- IES Types



TYPE III (T3)

TYPE V (T5)

FINISH

- 3-5 mils electrostatic powder coat.
- NLS Light's standard high-quality finishes prevent corrosion protects against and extreme environmental conditions.
- 10 Standard Finishes, Custom Finish and Marine Grade Finish Available

WARRANTY

Five-year limited warranty for drivers and LEDs.

LISTINGS

- UL Listed in compliance with UL 1598, the Standard for Safety of Luminaires, including the applicable wet location requirements
- Compliant with UL 8750 LED driver design and test safety standards
- CSA C22.2 No. 250.0

BUY AMERICAN OPTION

While all of the NLS Lighting products listed in this document qualify for the Buy America(n) Act of 1933, we reserve the right to change our listings without notice.

The information provided above is for general informational purposes only. We encourage you to consult legal professionals for advice particular to your projects concerning BAA, TAA, BABA or Buy America.

Additional NLS Products that meet BAA, TAA standards can be found at the following link:

<https://nslighting.com/buy-american/>



The information and specifications on this document are subject to change without any notification. All values are design, nominal, typical or prorated values when measured under internal and external laboratory conditions.



701 Kingshill Place, Carson, CA 90746
Call Us Today (310) 341-2037

nslighting.com

PRODUCT SPECIFICATIONS

DIMENSION	LEG-1
A	17.375 in
B	25.5 in
C	14 in

EPA	
SINGLE	.44

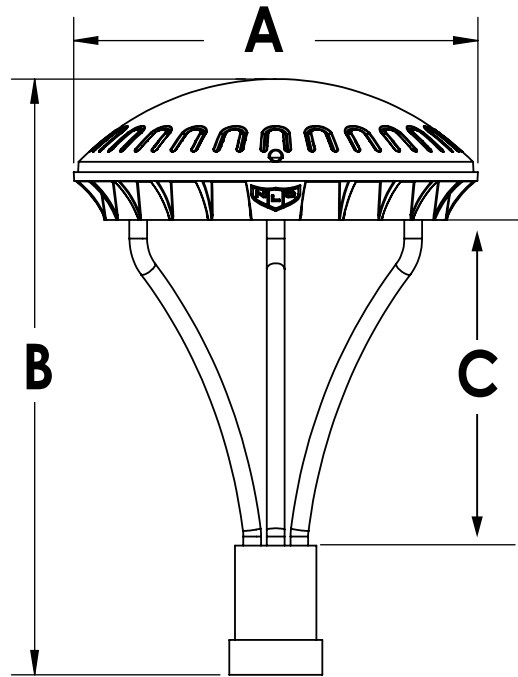

OVER 2-3/8" TO 4" OD Ø

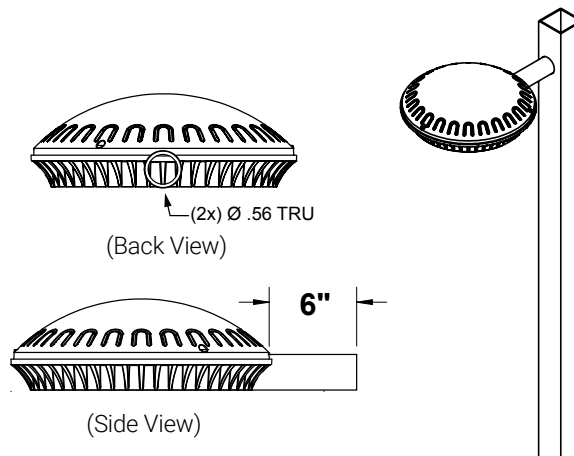

LEG-1 MAST ARM FITTER

PRODUCT SPECIFICATIONS

LED KELVIN RANGE

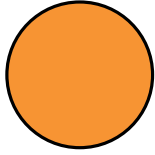

AMBER
585-600 nm

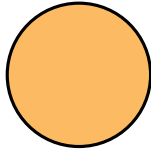

2700K 70 CRI

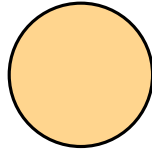

3000K 70 CRI

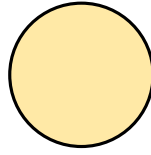

3500K 80 CRI

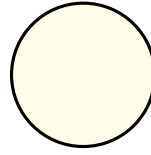

4000K 70 CRI

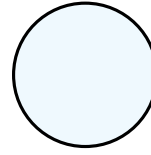

5000K 70 CRI

Color	Dominant or Peak Wavelength Range (nm)	
	Minimum	Maximum
Amber	585	600

LEGACY - LUMEN DATA CHART

PART NUMBER	T3 LUMENS	L/W	T5 LUMENS	L/W	Watts
LEG-1-16L-40-27K7	2025	96	2078	99	21
LEG-1-16L-40-27K8	1896	90	1945	93	21
LEG-1-16L-40-30K8	2033	97	2086	99	21
LEG-1-16L-40-30K7	2190	104	2246	107	21
LEG-1-16L-40-35K8	2033	97	2086	99	21
LEG-1-16L-40-40K8	2190	104	2246	107	21
LEG-1-16L-40-40K7	2366	113	2427	116	21
LEG-1-16L-40-50K8	2190	104	2246	107	21
LEG-1-16L-40-50K7	2366	113	2427	116	21
LEG-1-16L-53-30K7	2940	105	3108	111	28
LEG-1-16L-53-40K7	3080	110	3192	114	28
LEG-1-16L-53-50K7	3220	115	3304	118	28
LEG-1-16L-7-30K7	3780	105	3996	111	36
LEG-1-16L-7-40K7	3960	110	4104	114	36
LEG-1-16L-7-50K7	4140	115	4248	118	36
LEG-1-32L-35-30K7	3465	105	3663	111	33
LEG-1-32L-35-40K7	3630	110	3762	114	33
LEG-1-32L-35-50K7	3795	115	3894	118	33
LEG-1-32L-53-30K7	5670	105	5994	111	54
LEG-1-32L-53-40K7	5940	110	6156	114	54
LEG-1-32L-53-50K7	6210	115	6372	118	54
LEG-1-32L-7-30K7	7455	105	7881	111	71
LEG-1-32L-7-40K7	7810	110	8094	114	71
LEG-1-32L-7-50K7	8165	115	8378	118	71
LEG-1-48L-35-30K7	5355	105	5661	111	51
LEG-1-48L-35-40K7	5610	110	5814	114	51
LEG-1-48L-35-50K7	5865	115	6018	118	51
LEG-1-48L-53-30K7	8400	105	8880	111	80
LEG-1-48L-53-40K7	8800	110	9120	114	80
LEG-1-48L-53-50K7	9200	115	9440	118	80
LEG-1-48L-7-30K7	10920	105	11544	111	104
LEG-1-48L-7-40K7	11440	110	11856	114	104
LEG-1-48L-7-50K7	11960	115	12272	118	104
LEG-1-64L-35-30K7	6930	105	7326	111	66
LEG-1-64L-35-40K7	7260	110	7524	114	66
LEG-1-64L-35-50K7	7590	115	7788	118	66
LEG-1-64L-53-30K7	10710	105	11322	111	102
LEG-1-64L-53-40K7	11220	110	11628	114	102
LEG-1-64L-53-50K7	11730	115	12036	118	102

PRODUCT SPECIFICATIONS

CONTROL OPTIONS

- DIMMING CONTROL (FSP)—Passive infrared (PIR) sensor providing multi-level control based on motion/daylight contribution
- All control parameters adjustable via wireless configuration remote storing and transmitting sensor profiles.
- FSP-8 mounting heights 8 feet and below
- FSP-20 mounting heights 9-20 feet.
- FSP-40 mounting heights 21-40 feet.
- Includes 5 dimming event cycles, 0-10V dimming with motion sensing, re-programmable in the field.

FSP-211 WITH MOTION SENSOR (FSP-XX)

- FSP-211(FSP-X)—Passive infrared (PIR) sensor providing multi-level control based on motion/daylight contribution.
- 120/277VAC, 230-240VAC
- All control parameters adjustable via wireless configuration remote storing and transmitting sensor profiles.
- FSP-8 mounting heights 8 feet and below
- FSP-20 mounting heights 9-20 feet.
- FSP-40 mounting heights 21-40 feet.
- Includes 5 dimming event cycles, 0-10V dimming with motion sensing, re-programmable in the field.

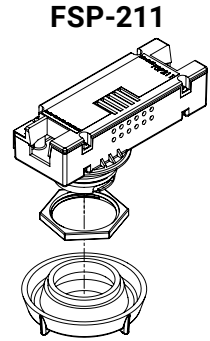

FSP-221 WITH MOTION SENSOR (FSP-HV-XX)

- FSP-221 (FSP-HV-X)—Passive infrared (PIR) sensor providing multi-level control based on motion/daylight contribution.
- 100-347VAC 208/230/480VAC
- All control parameters adjustable via wireless configuration remote storing and transmitting sensor profiles.
- FSP-8 mounting heights 8 feet and below
- FSP-20 mounting heights 9-20 feet.
- FSP-40 mounting heights 21-40 feet.
- Includes 5 dimming event cycles, 0-10V dimming with motion sensing, re-programmable in the field.

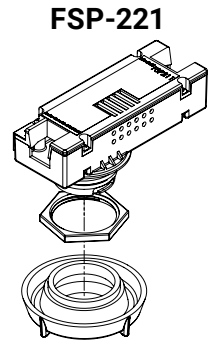

FSP-8

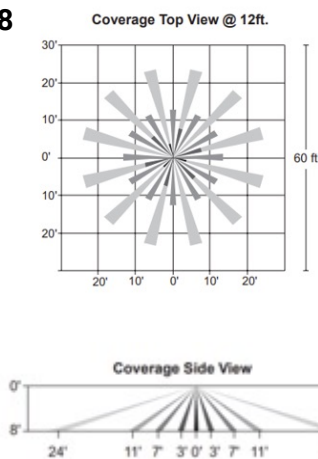

FSP-20

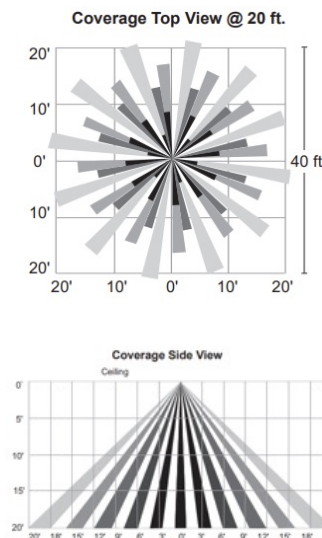

FSP-40

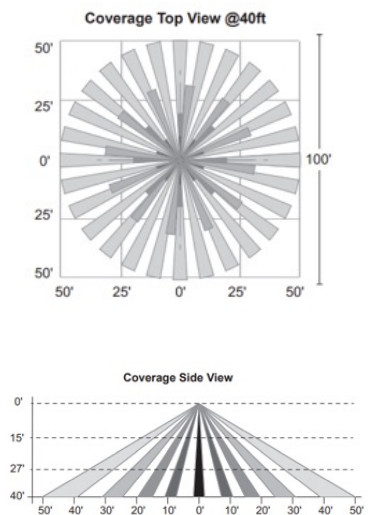

PRODUCT SPECIFICATIONS

BUTTON PHOTOCELL

Photo Cell for dusk to dawn operation.

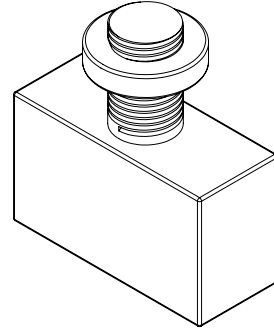

SHIELDING OPTIONS (HSS)

SHIELDS (HSS, AHS)—House Side Shield (HSS) is designed for full property line cut-off.

HOUSE SIDE SHIELD

