



APPLICATIONS

The Groove 48V DC track system is available with multiple sleek, slender, and compact track heads that can be seamlessly mounted onto the track by simply clicking the track head's connector into place, allowing you to interchange one Groove-compatible luminaire for another. The Groove's intuitive click-in track makes it easy to install and switch luminaires, so the system can be updated to match any design or application, current or future.

The Groove track system is available in Trimless Recessed, Recessed Flanged, Ceiling/Surface, and Suspended options, and can be integrated in most ceiling and wall applications. Utilize suspended and surface mounting options for surface such as wood, drywall or T-Bar ceilings.

The Groove offers a variety of connector accessories that enable users to tailor their designs with custom rectangular, square, or many other linear patterns. The T, X, L Corners and power connectors create dynamic designs that transcend flat surfaces including wall to ceiling, wrap corners, and more.

Drivers can be stowed within the system, hidden from view, or placed in a remote location. The single driver can power runs up to 65' long and 480 Watts. Please refer to driver spec sheets for more detailed information. Our team at Elite Lighting can help you organize the placement of drivers and complete systems.

Fixtures can be installed individually or combined with other Groove track system luminaires to create the perfect design. Multiple linear fixtures can be mounted next to each other on one track for continuous rays of illumination.

Available track head options are in-line linear, adjustable linear, spot, pendant, cylinder, and suspended. Many track heads are crafted with black interiors and TIR optics, providing precise beam control and reducing glare. Most track heads that are available with optics are field-changeable, with various lumen and distribution options. Additionally, some track heads can be overlaid with a single optical accessory, like the Linear Diffuser, Frosted Diffuser, and Honeycomb accessories. Some track heads can be used with spot-light, flood-light, snoot, and wall-wash accessories. (Please refer to the spec sheet on each individual track head for more detailed information.)

Subsequently, the system can be used for accent, task, and general illumination, making it ideal for a plethora of applications, such as galleries, museums, hospitality spaces, retail spaces, corporate offices, and residential spaces.

CONSTRUCTION

All track heads are engineered to have an extremely long lifespan and service period by using coolLED's Advanced Thermodynamic Design, which includes an extruded aluminum body, a hidden diecast heat sink, and a thermal management system.

LED MODULE PERFORMANCE

The Groove System's luminaires are equipped with 2-step McAdam Eclipse LEDs, which provide consistent color across all fixtures, and 90+CRI. The LEDs are available in a variety of kelvin temperature options.

DRIVERS

The Groove System is powered by constant voltage drivers with a rating of 50/60Hz at a 120/277V input and a 48V output. They produce less than 20% THD, have a 90% power factor, and are thermally protected for additional safety. Driver wattages range from 75W to 450W and can power up to 65' of track. Groove drivers can be installed internally within the track or remotely mounted, and are available in 0-10V 1% Dimming, Dali Dimming, or 120V On/ Off Non-Dimming Driver. Please see Groove track system spec sheets for a complete list of drivers and capabilities.

DIMMING INFORMATION

DIM10 - 0-10V dimming on either MVOLT 120, 277. Dimmable down to 1% of initial lumens, standard. Available in 75W, 100W, 150W, 240W.
DIMTR - Electronic low voltage dimming. Available in 120V.
DALI - DALI DT6 dimming down to 1% Available in 75W, 100W, 150W, 240W.
EldoLED PowerDrive dimming down to 0.1%. Please see the EldoLED website for wiring diagrams and a full list of compatible DMX and DALI control systems.

FINISH

Luminaires are available in a powder-coated black or white post-paint finish. They may also be issued in custom RAL colors upon request. Consult the factory to find out which custom colors can be accommodated.

WARRANTY

Five-year warranty for parts and components.

RECESSED TRACK OPTIONS

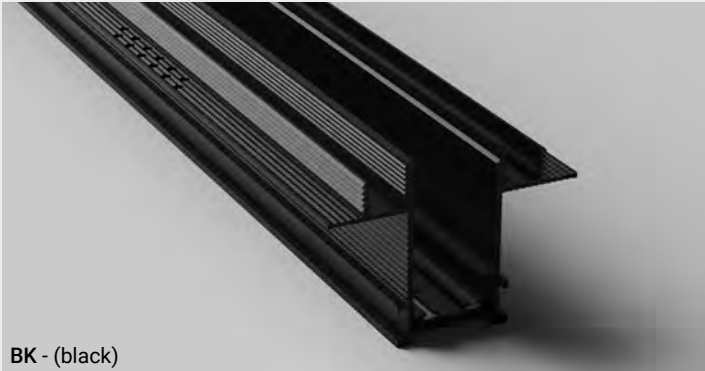

BK - (black)



WH - (white)

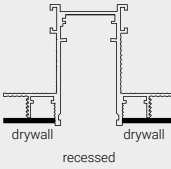
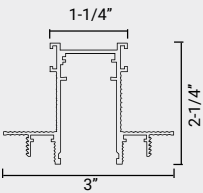

FG-RTL-2

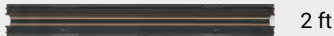

FG-RTL-4

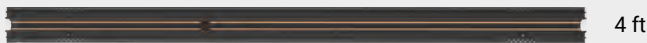

FG-RTL-8

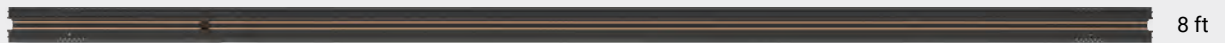

TRACK CORNERS

● BK - (black) ○ WH - (white)

FG-RTL-ACC-2

"L" track Connector for Same Plane

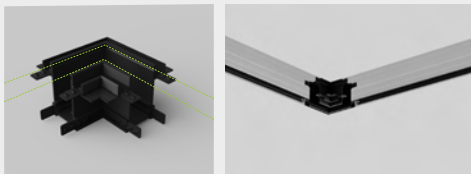
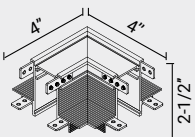

FG-RTL-ACC-5

"T" track Connector for Same Plane

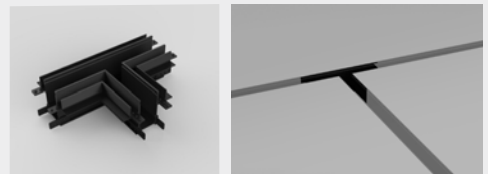
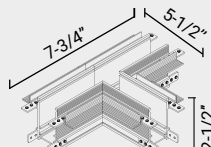

FG-RTL-ACC-3

"L" track Connector for inside corner of two surfaces

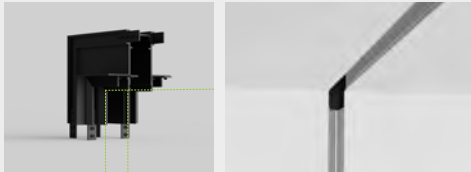
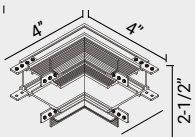

FG-RTL-ACC-6

"X" track Connector for inner corner of two surfaces

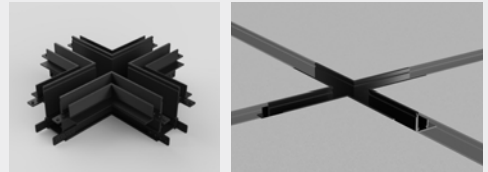
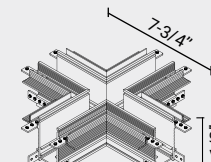

FG-RTL-ACC-4

"L" track Connector for outside corner of two surfaces

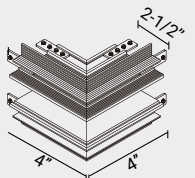

CORNERS EXAMPLE



ACCESSORIES

● BK - (black) ○ WH - (white)

FG-ACC-1

Endcap (to close the open ends of tracks)

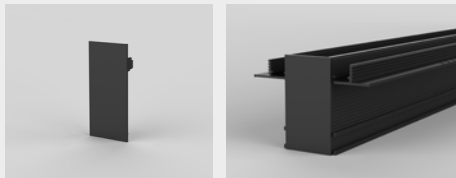
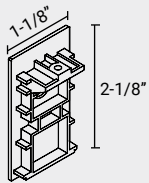

**FG-ACC-2-2 (2')
FG-ACC-2-4 (4')
FG-ACC-2-8 (8')**

Track Cover Cap (to avoid dust or decorate)

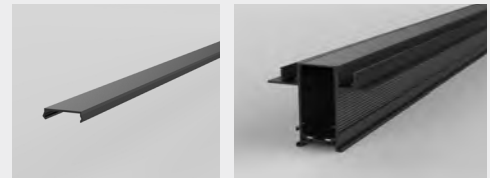
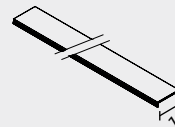

FG-ACC-3

Live-end with cable

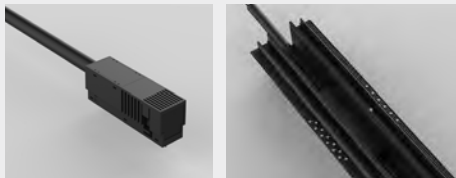
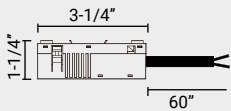

FG-ACC-4

Power Connector (Between Straight Tracks)

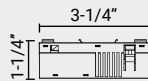

FG-ACC-5

Power Connector (flexible cable)

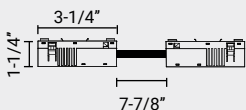

FG-ACC-5-L

Power Connector for 'T' form Corners (flexible cable)

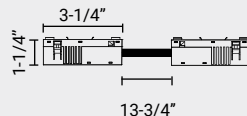

FG-ACC-9

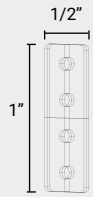

Track Connector

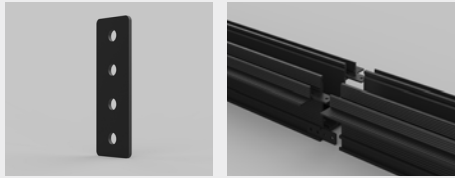

INTERNAL DRIVER OPTIONS (with box): ● BK - (black) ○ WH - (white)

Install the driver into ceiling or into the actual track with the following driver box options

FG-DI-200W-ON-OFF-48V

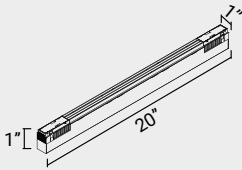

Voltage: 120V
Maximum Load: 200W
Dimming Option: Power ON/OFF

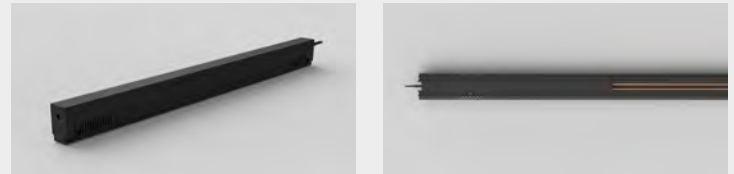

FG-DI-200W-10V-DIM-48V

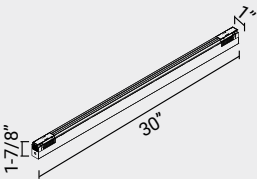

Voltage: 120V
Maximum Load: 200W
Dimming Option: 0-10V Dimmable

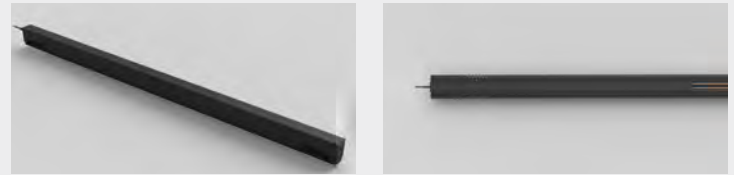

FG-DI-200W-DALI-48V

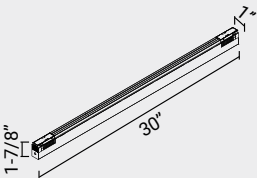

Voltage: 120V
Maximum Load: 200W
Dimming Option: Dali Dimmable

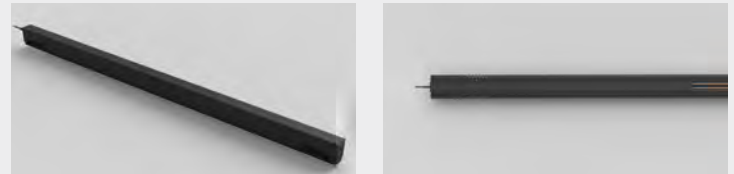

EXTERNAL DRIVER OPTIONS (with box):

PN: FG-DR-75W-48V

ELG-75 Series Constant Voltage + Constant Current Driver								
Model	Input Voltage	Output Voltage	Wattage (@120VAC)	Wattage (@277VAC)	Rated Current	Efficiency	Frequency	Power Factor (Normal)
ELG-75-48	120-277VAC 2	24-48V	60W	76.8W	1.6A	90%	50-60Hz	.9

0-10V & DALI dimming only

EXTERNAL DRIVER OPTIONS:

PN: FG-DR-100W-48V

ELG-100 Series Constant Voltage + Constant Current Driver								
Model	Input Voltage	Output Voltage	Wattage (@120VAC)	Wattage (@277VAC)	Rated Current	Efficiency	Frequency	Power Factor (Normal)
ELG-100-48	120-277VAC	24-48V	70W	96W	2A	90%	50-60Hz	.9

0-10V & DALI dimming only

PN: FG-DR-150W-48V

ELG-150 Series Constant Voltage + Constant Current Driver								
Model	Input Voltage	Output Voltage	Wattage * (@120VAC)	Wattage * (@277VAC)	Rated Current *	Efficiency *	Frequency	Power Factor (Normal)
ELG-150-48	120-277VAC	24-48V	105W	150W	3A	90%	50-60Hz	.9

0-10V & DALI dimming only

Type BE has different Wattage, Current & Efficiency See Chart Below

PN: FG-DR-200W-48V

ELG-200 Series Constant Voltage + Constant Current Driver								
Model	Input Voltage	Output Voltage	Wattage * (@120VAC)	Wattage * (@277VAC)	Rated Current *	Efficiency *	Frequency	Power Factor (Normal)
ELG-200-48	120-277VAC	24-48V	150W	200W	4.16A	93%	50-60Hz	.9

0-10V & DALI dimming only

PN: FG-DR-320W-48V

HLG-320 Series Constant Voltage + Constant Current Driver								
Model	Input Voltage	Output Voltage	Wattage * (@120VAC)	Wattage * (@277VAC)	Rated Current *	Efficiency *	Frequency	Power Factor (Normal)
HLG-320H-48	120-277VAC	24-48V	320W	320W	6A	95%	50-60Hz	.9

0-10V & DALI dimming only

PN: FG-DR-480W-48V

HLG-480 Series Constant Voltage + Constant Current Driver								
Model	Input Voltage	Output Voltage	Wattage * (@120VAC)	Wattage * (@277VAC)	Rated Current *	Efficiency *	Frequency	Power Factor (Normal)
ELG-480H-48	120-277VAC	24-48V	480W	480W	10A	94%	50-60Hz	.9

0-10V & DALI dimming only

DRIVER: FG-DR-75W-48V

Unit: Inches

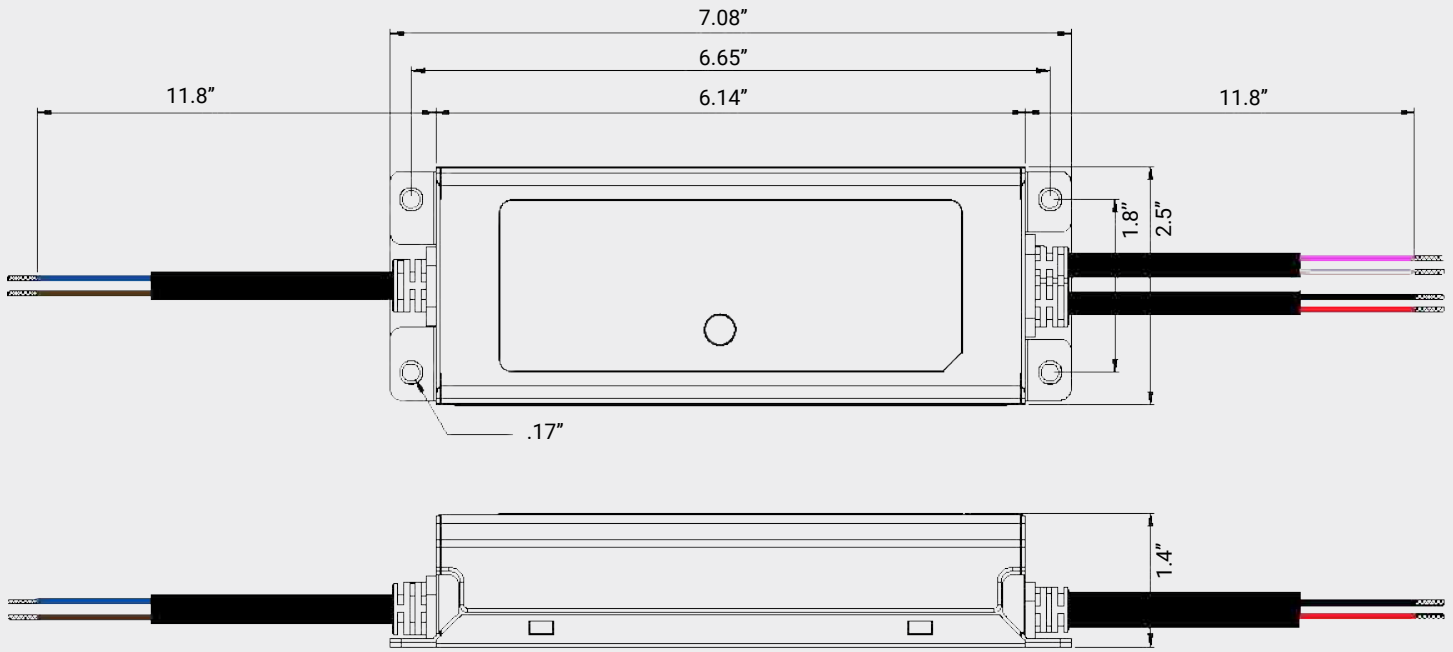

FG-DR-ELG-100-48

DRIVER: FG-DR-100W-48V

Unit: Inches

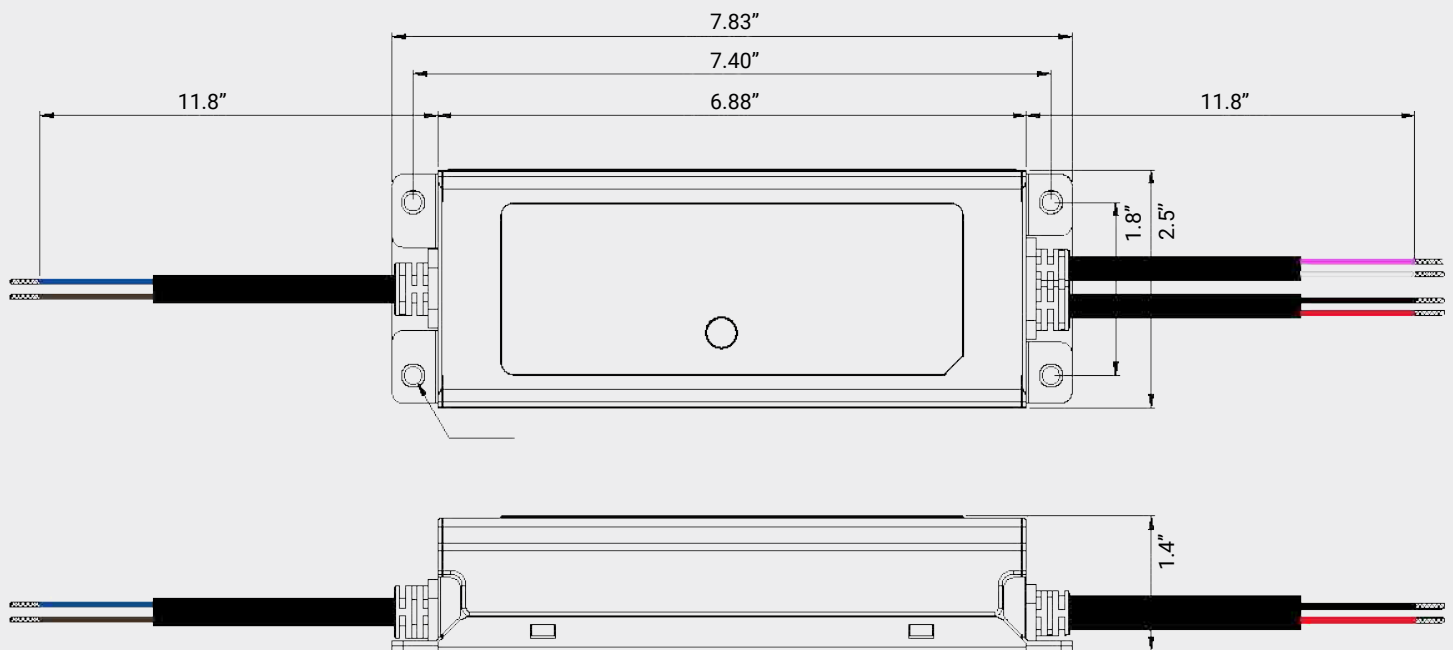

DRIVER: FG-DR-150W-48V

Unit: Inches

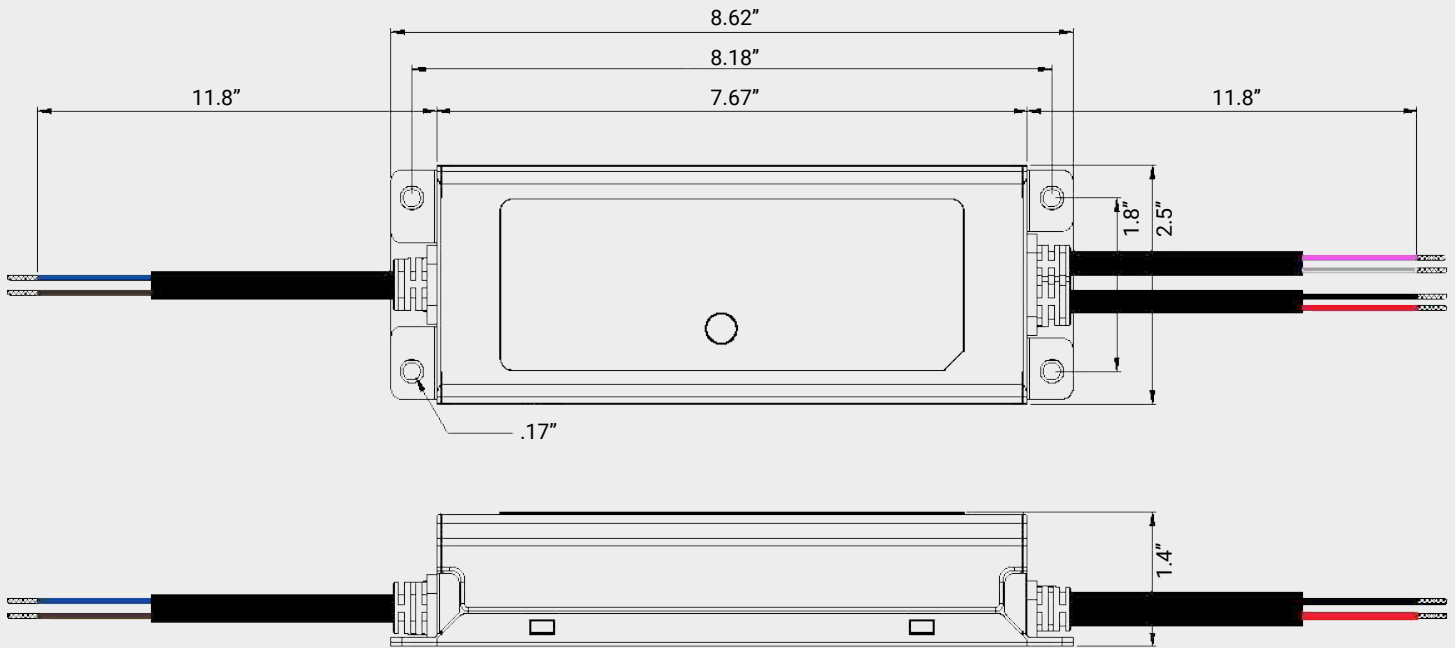

DRIVER: FG-DR-200W-48V

Unit: Inches

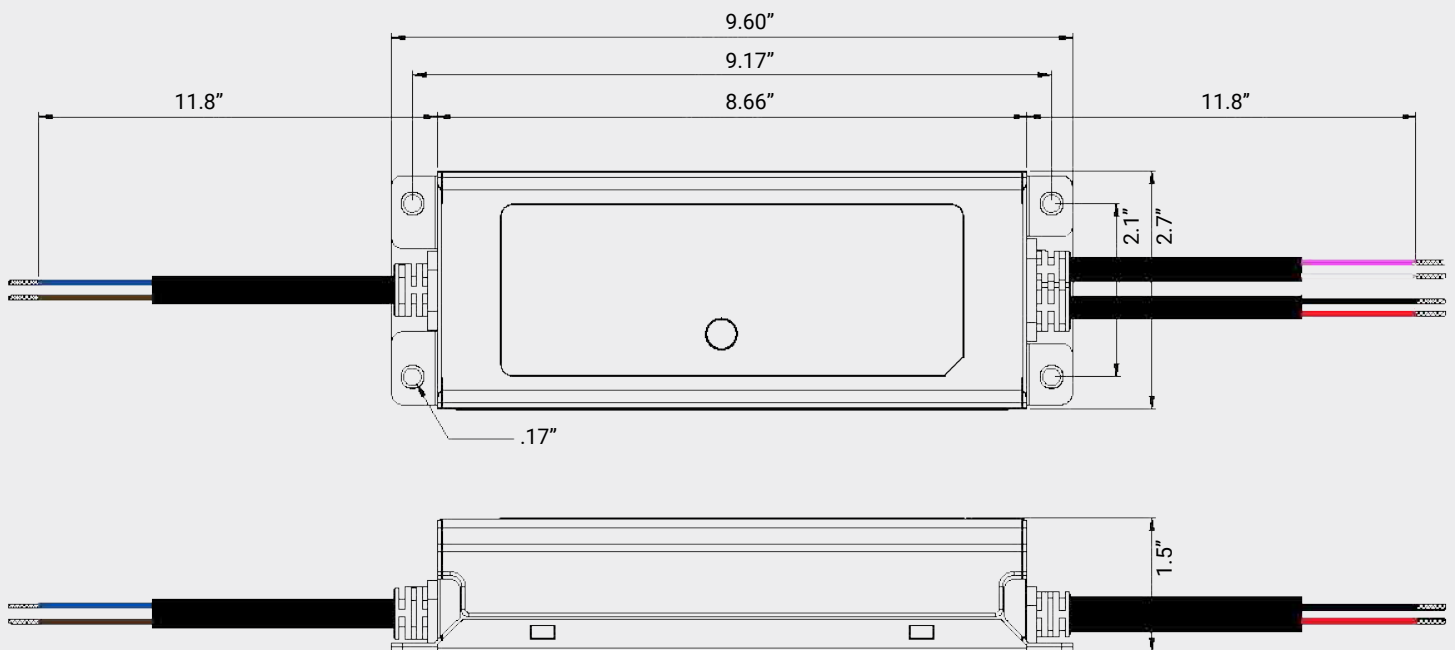

DRIVER: FG-DR-320W-48V

Unit: Inches

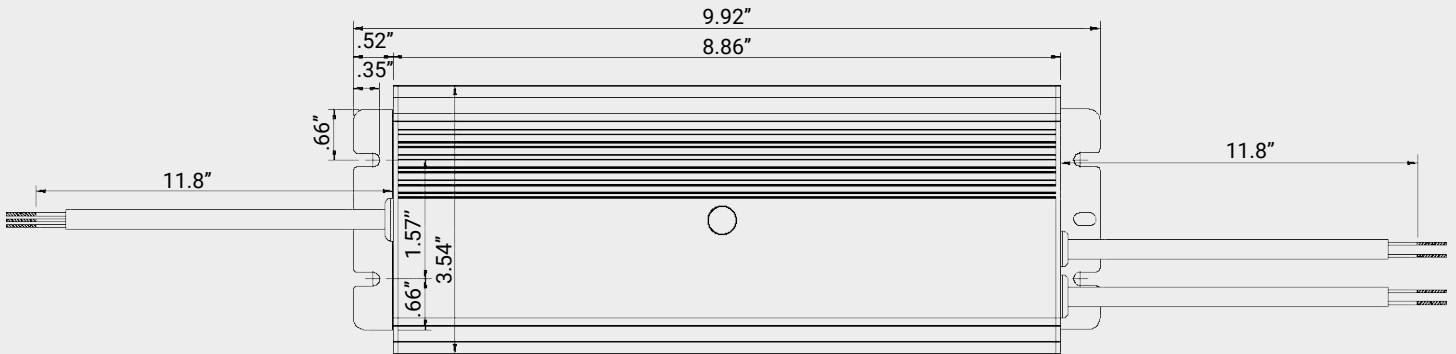

DRIVER: FG-DR-480W-48V

Unit: Inches

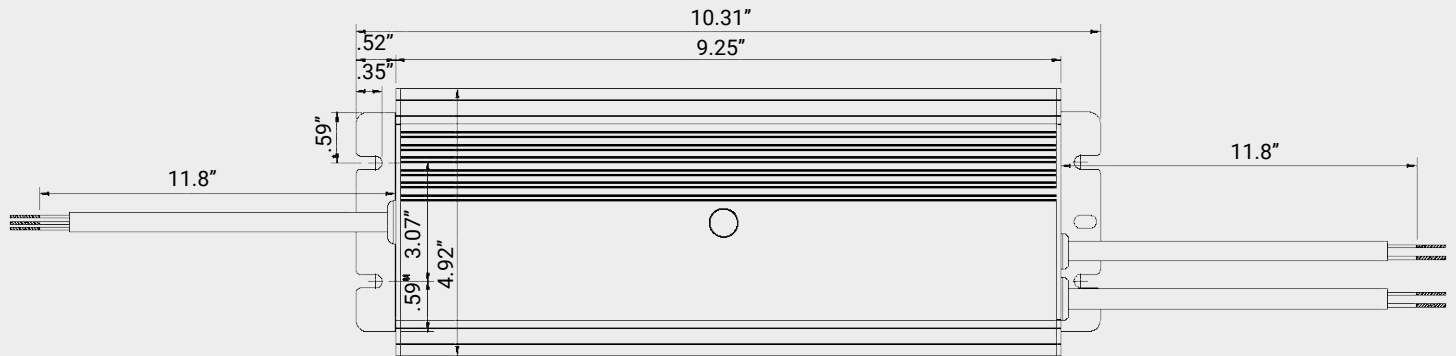

DRIVER BOX DIMENSION

Unit: Inches

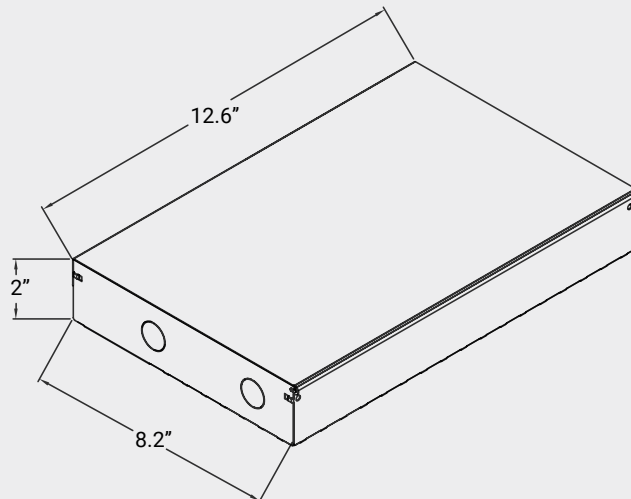

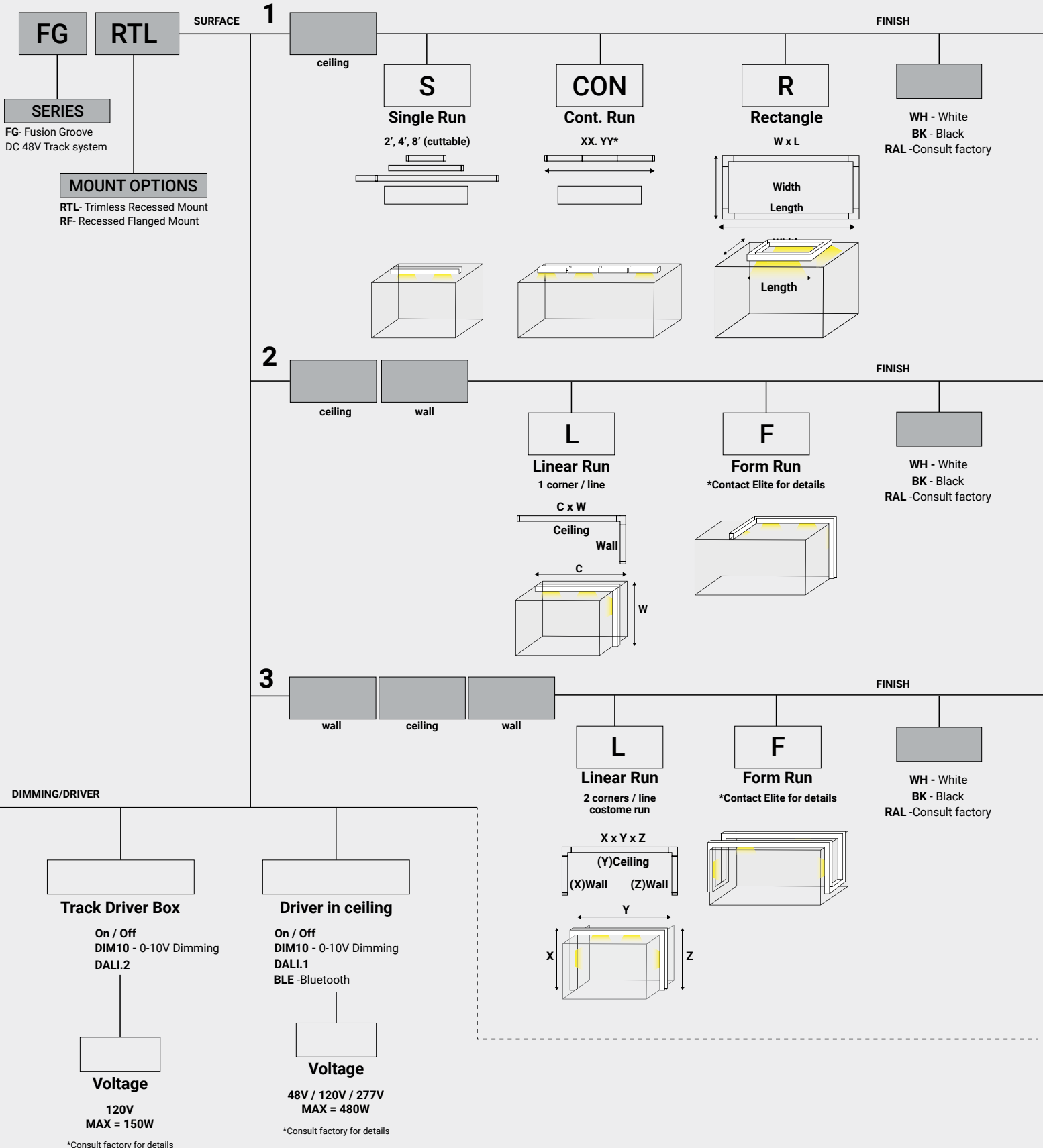



APPLICATIONS

The Groove 48V DC track system is available with multiple sleek, slender, and compact track heads that can be seamlessly mounted onto the track by simply clicking the track head's connector into place, allowing you to interchange one Groove-compatible luminaire for another. The Groove's intuitive click-in track makes it easy to install and switch luminaires, so the system can be updated to match any design or application, current or future.

The Groove track system is available in Trimless Recessed, Recessed Flanged, Ceiling/Surface, and Suspended options, and can be integrated in most ceiling and wall applications. Utilize suspended and surface mounting options for surface such as wood, drywall or T-Bar ceilings.

The Groove offers a variety of connector accessories that enable users to tailor their designs with custom rectangular, square, or many other linear patterns. The T, X, L Corners and power connectors create dynamic designs that transcend flat surfaces including wall to ceiling, wrap corners, and more.

Drivers can be stowed within the system, hidden from view, or placed in a remote location. The single driver can power runs up to 65' long and 480 Watts. Please refer to driver spec sheets for more detailed information. Our team at Elite Lighting can help you organize the placement of drivers and complete systems.

Fixtures can be installed individually or combined with other Groove track system luminaires to create the perfect design. Multiple linear fixtures can be mounted next to each other on one track for continuous rays of illumination.

Available track head options are in-line linear, adjustable linear, spot, pendant, cylinder, and suspended. Many track heads are crafted with black interiors and TIR optics, providing precise beam control and reducing glare. Most track heads that are available with optics are field-changeable, with various lumen and distribution options. Additionally, some track heads can be overlaid with a single optical accessory, like the Linear Diffuser, Frosted Diffuser, and Honeycomb accessories. Some track heads can be used with spot-light, flood-light, snoot, and wall-wash accessories. (Please refer to the spec sheet on each individual track head for more detailed information.)

Subsequently, the system can be used for accent, task, and general illumination, making it ideal for a plethora of applications, such as galleries, museums, hospitality spaces, retail spaces, corporate offices, and residential spaces.

CONSTRUCTION

All track heads are engineered to have an extremely long lifespan and service period by using coolLED's Advanced Thermodynamic Design, which includes an extruded aluminum body, a hidden diecast heat sink, and a thermal management system.

LED MODULE PERFORMANCE

The Groove System's luminaires are equipped with 2-step McAdam Eclipse LEDs, which provide consistent color across all fixtures, and 90+CRI. The LEDs are available in a variety of kelvin temperature options.

DRIVERS

The Groove System is powered by constant voltage drivers with a rating of 50/60Hz at a 120/277V input and a 48V output. They produce less than 20% THD, have a 90% power factor, and are thermally protected for additional safety. Driver wattages range from 75W to 450W and can power up to 65' of track. Groove drivers can be installed internally within the track or remotely mounted, and are available in 0-10V 1% Dimming, Dali Dimming, or 120V On/ Off Non-Dimming Driver. Please see Groove track system spec sheets for a complete list of drivers and capabilities.

DIMMING INFORMATION

DIM10 - 0-10V dimming on either MVOLT 120, 277. Dimmable down to 1% of initial lumens, standard. Available in 75W, 100W, 150W, 240W.
DIMTR - Electronic low voltage dimming. Available in 120V.
DALI - DALI DT6 dimming down to 1% Available in 75W, 100W, 150W, 240W.
EldoLED PowerDrive dimming down to 0.1%. Please see the EldoLED website for wiring diagrams and a full list of compatible DMX and DALI control systems.

FINISH

Luminaires are available in a powder-coated black or white post-paint finish. They may also be issued in custom RAL colors upon request. Consult the factory to find out which custom colors can be accommodated.

WARRANTY

Five-year warranty for parts and components.

SURFACE MOUNT TRACK OPTIONS

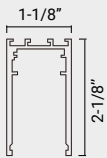
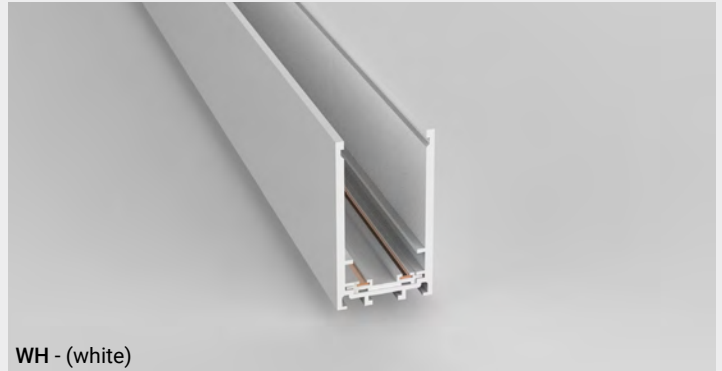
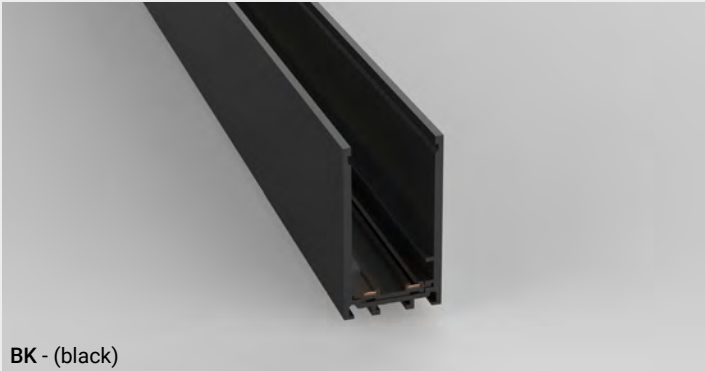

FG-CM-SM-2



FG-CM-SM-4

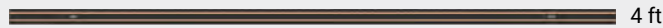

FG-CM-SM-8

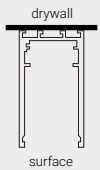
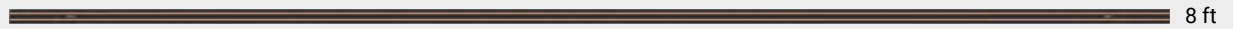

TRACK CORNERS

● BK - (black) ○ WH - (white)

FG-CM-SM-ACC-2

"L" track Connector for Same Plane

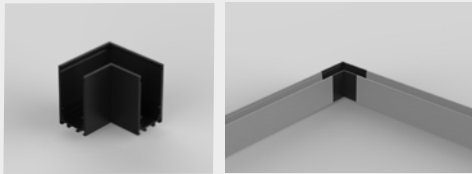
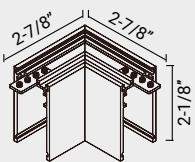

FG-CM-SM-ACC-5

"T" track Connector for Same Plane

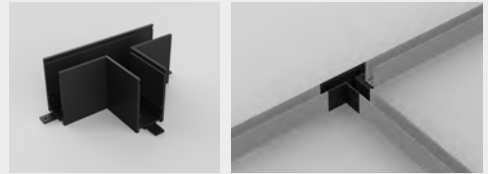
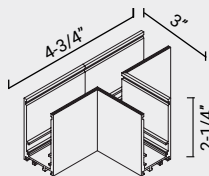

FG-CM-SM-ACC-3

"L" track Connector for inside corner of two surfaces

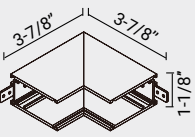

FG-CM-SM-ACC-6

"X" track Connector for inner corner of two surfaces

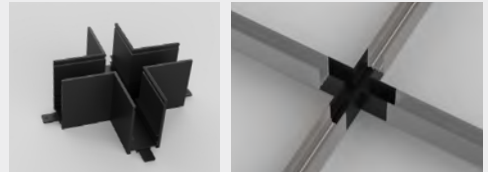
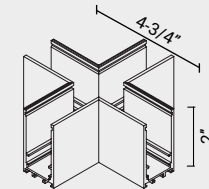

FG-CM-SM-ACC-4

"L" track Connector for outside corner of two surfaces

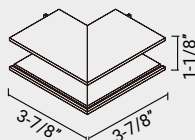

CORNERS EXAMPLE

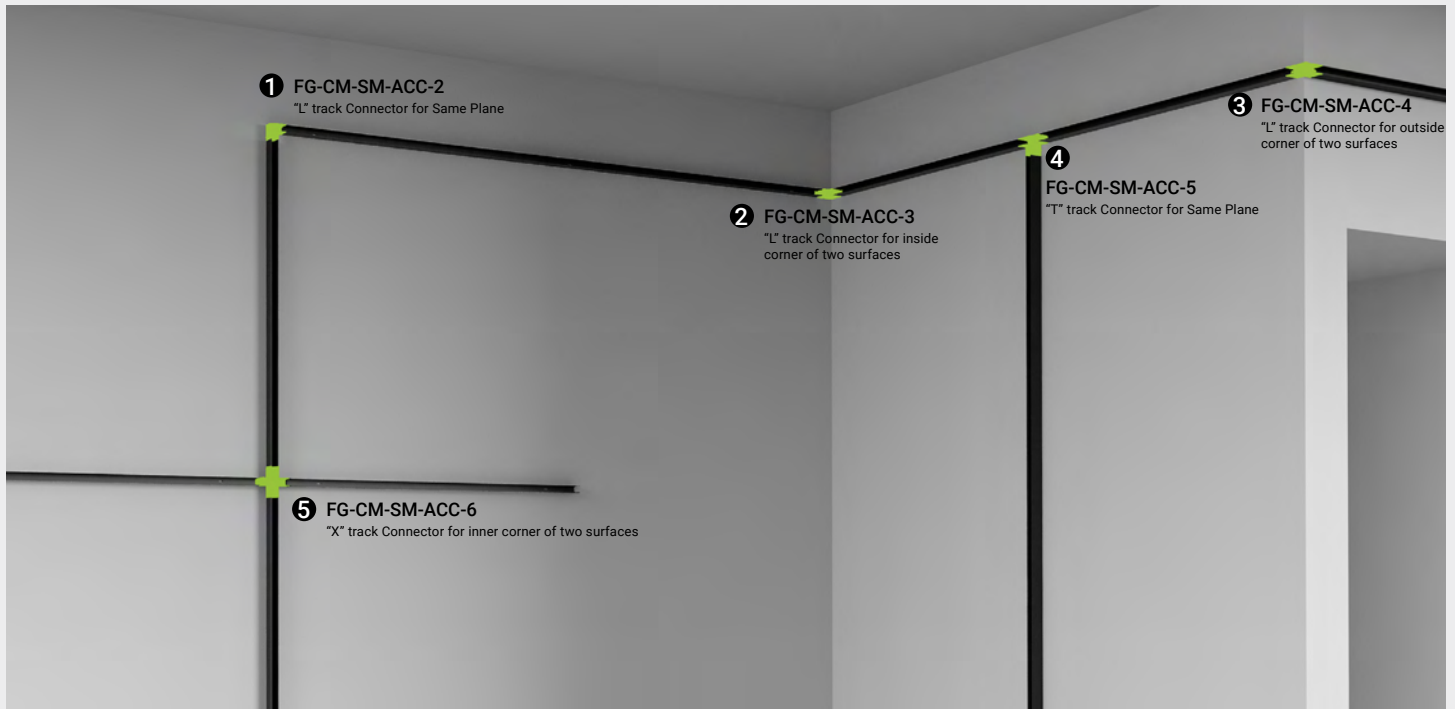

ACCESSORIES

● BK - (black) ○ WH - (white)

FG-ACC-1

Endcap (to close the open ends of tracks)

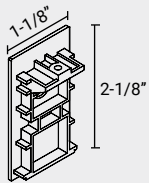

FG-ACC-2-2 (2')
FG-ACC-2-4 (4')
FG-ACC-2-8 (8')

Track Cover Cap (to avoid dust or decorate)

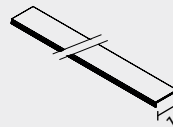

FG-ACC-3

Live-end with cable

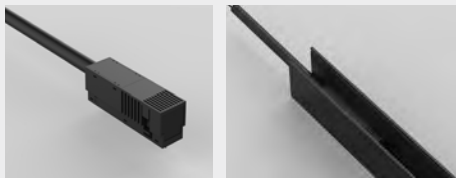
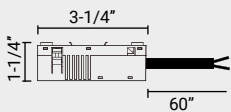

FG-ACC-4

Power Connector (Between Straight Tracks)

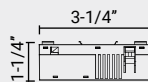

FG-ACC-5

Power Connector (flexible cable)

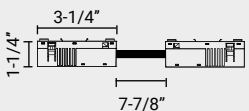

FG-ACC-5-L

Power Connector for "T" Corners (flexible cable)

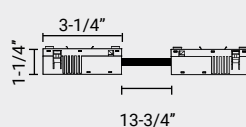

FG-ACC-9

Track Connector

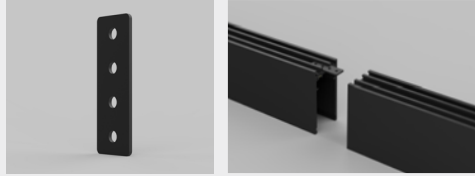
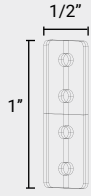

INTERNAL DRIVER OPTIONS (with box): ● BK - (black) ○ WH - (white)

Install the driver into ceiling or into the actual track with the following driver box options

FG-DI-200W-ON-OFF-48V

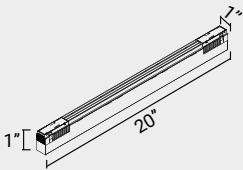

Voltage: 120V
Maximum Load: 200W
Dimming Option: Power ON/OFF

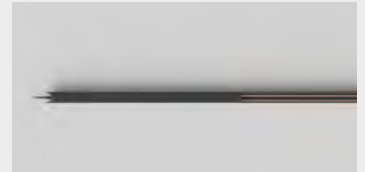
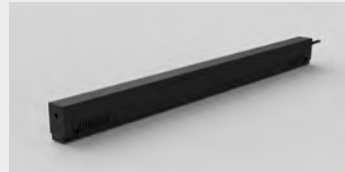

FG-DI-200W-10V-DIM-48V

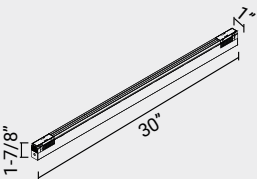

Voltage: 120V
Maximum Load: 200W
Dimming Option: 0-10V Dimmable

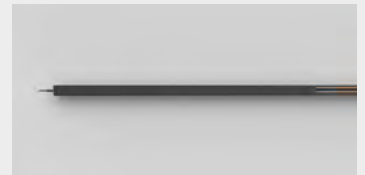

FG-DI-200W-DALI-48V

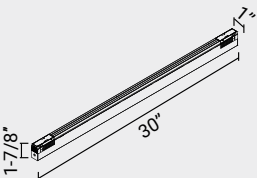

Voltage: 120V
Maximum Load: 200W
Dimming Option: Dali Dimmable

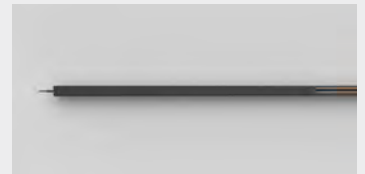

EXTERNAL DRIVER OPTIONS (with box):

PN: FG-DR-75W-48V

ELG-75 Series Constant Voltage + Constant Current Driver								
Model	Input Voltage	Output Voltage	Wattage (@120VAC)	Wattage (@277VAC)	Rated Current	Efficiency	Frequency	Power Factor (Normal)
ELG-75-48	120-277VAC 2	24-48V	60W	76.8W	1.6A	90%	50-60Hz	.9

0-10V & DALI dimming only

EXTERNAL DRIVER OPTIONS:

PN: FG-DR-100W-48V

ELG-100 Series Constant Voltage + Constant Current Driver								
Model	Input Voltage	Output Voltage	Wattage (@120VAC)	Wattage (@277VAC)	Rated Current	Efficiency	Frequency	Power Factor (Normal)
ELG-100-48	120-277VAC	24-48V	70W	96W	2A	90%	50-60Hz	.9

0-10V & DALI dimming only

PN: FG-DR-150W-48V

ELG-150 Series Constant Voltage + Constant Current Driver								
Model	Input Voltage	Output Voltage	Wattage * (@120VAC)	Wattage * (@277VAC)	Rated Current *	Efficiency *	Frequency	Power Factor (Normal)
ELG-150-48	120-277VAC	24-48V	105W	150W	3A	90%	50-60Hz	.9

0-10V & DALI dimming only

Type BE has different Wattage, Current & Efficiency See Chart Below

PN: FG-DR-200W-48V

ELG-200 Series Constant Voltage + Constant Current Driver								
Model	Input Voltage	Output Voltage	Wattage * (@120VAC)	Wattage * (@277VAC)	Rated Current *	Efficiency *	Frequency	Power Factor (Normal)
ELG-200-48	120-277VAC	24-48V	150W	200W	4.16A	93%	50-60Hz	.9

0-10V & DALI dimming only

PN: FG-DR-320W-48V

HLG-320 Series Constant Voltage + Constant Current Driver								
Model	Input Voltage	Output Voltage	Wattage * (@120VAC)	Wattage * (@277VAC)	Rated Current *	Efficiency *	Frequency	Power Factor (Normal)
HLG-320H-48	120-277VAC	24-48V	320W	320W	6A	95%	50-60Hz	.9

0-10V & DALI dimming only

PN: FG-DR-480W-48V

HLG-480 Series Constant Voltage + Constant Current Driver								
Model	Input Voltage	Output Voltage	Wattage * (@120VAC)	Wattage * (@277VAC)	Rated Current *	Efficiency *	Frequency	Power Factor (Normal)
HLG-480H-48	120-277VAC	24-48V	480W	480W	10A	94%	50-60Hz	.9

0-10V & DALI dimming only

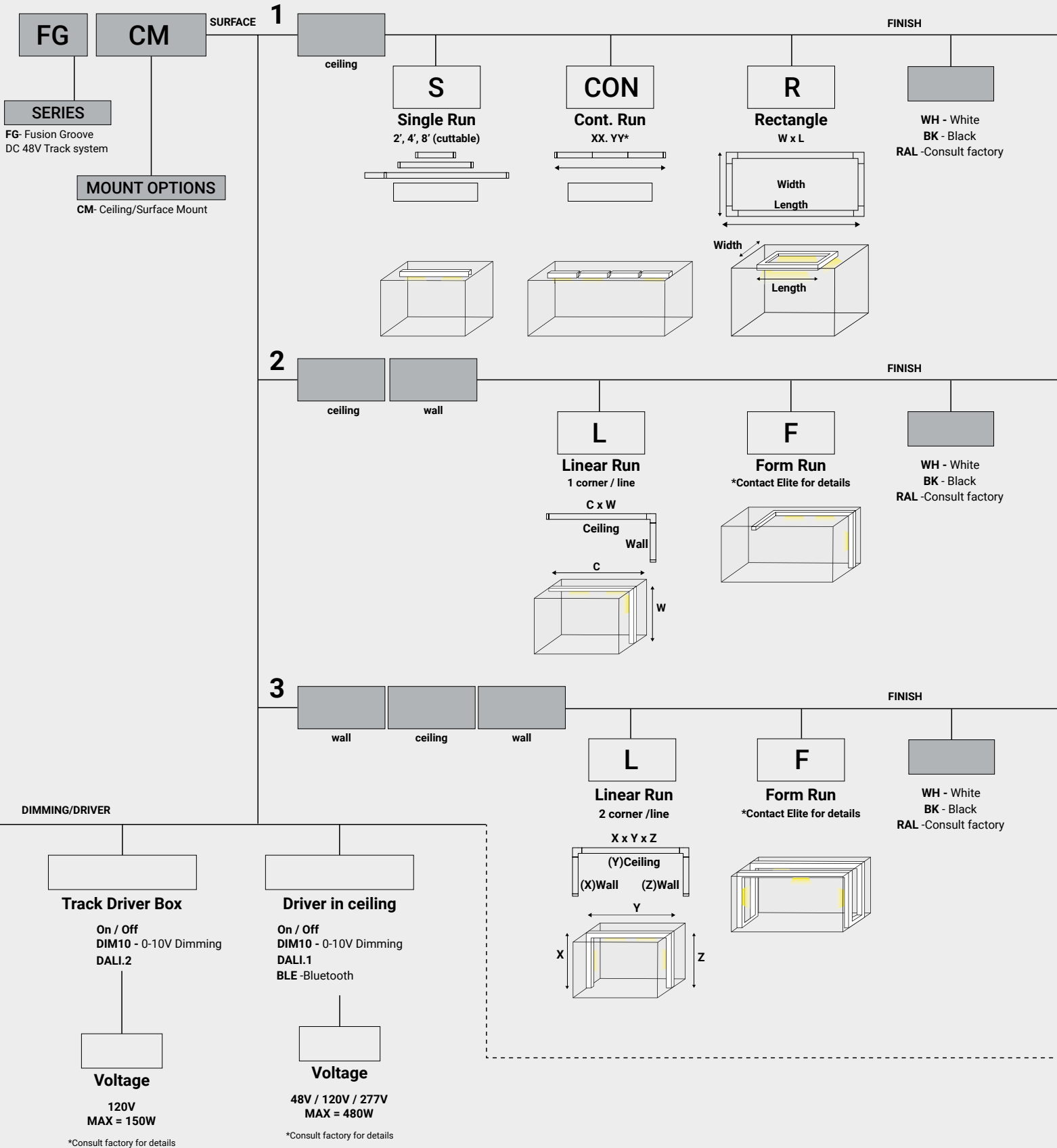



APPLICATIONS

The Groove 48V DC track system is available with multiple sleek, slender, and compact track heads that can be seamlessly mounted onto the track by simply clicking the track head's connector into place, allowing you to interchange one Groove-compatible luminaire for another. The Groove's intuitive click-in track makes it easy to install and switch luminaires, so the system can be updated to match any design or application, current or future.

The Groove track system is available in Trimless Recessed, Recessed Flanged, Ceiling/Surface, and Suspended options, and can be integrated in most ceiling and wall applications. Utilize suspended and surface mounting options for surface such as wood, drywall or T-Bar ceilings.

The Groove offers a variety of connector accessories that enable users to tailor their designs with custom rectangular, square, or many other linear patterns. The T, X, L Corners and power connectors create dynamic designs that transcend flat surfaces including wall to ceiling, wrap corners, and more.

Drivers can be stowed within the system, hidden from view, or placed in a remote location. The single driver can power runs up to 65' long and 480 Watts. Please refer to driver spec sheets for more detailed information. Our team at Elite Lighting can help you organize the placement of drivers and complete systems.

Fixtures can be installed individually or combined with other Groove track system luminaires to create the perfect design. Multiple linear fixtures can be mounted next to each other on one track for continuous rays of illumination.

Available track head options are in-line linear, adjustable linear, spot, pendant, cylinder, and suspended. Many track heads are crafted with black interiors and TIR optics, providing precise beam control and reducing glare. Most track heads that are available with optics are field-changeable, with various lumen and distribution options. Additionally, some track heads can be overlaid with a single optical accessory, like the Linear Diffuser, Frosted Diffuser, and Honeycomb accessories. Some track heads can be used with spot-light, flood-light, snoot, and wall-wash accessories. (Please refer to the spec sheet on each individual track head for more detailed information.)

Subsequently, the system can be used for accent, task, and general illumination, making it ideal for a plethora of applications, such as galleries, museums, hospitality spaces, retail spaces, corporate offices, and residential spaces.

CONSTRUCTION

All track heads are engineered to have an extremely long lifespan and service period by using coolLED's Advanced Thermodynamic Design, which includes an extruded aluminum body, a hidden diecast heat sink, and a thermal management system.

LED MODULE PERFORMANCE

The Groove System's luminaires are equipped with 2-step McAdam Eclipse LEDs, which provide consistent color across all fixtures, and 90+CRI. The LEDs are available in a variety of kelvin temperature options.

DRIVERS

The Groove System is powered by constant voltage drivers with a rating of 50/60Hz at a 120/277V input and a 48V output. They produce less than 20% THD, have a 90% power factor, and are thermally protected for additional safety. Driver wattages range from 75W to 450W and can power up to 65' of track. Groove drivers can be installed internally within the track or remotely mounted, and are available in 0-10V 1% Dimming, Dali Dimming, or 120V On/ Off Non-Dimming Driver. Please see Groove track system spec sheets for a complete list of drivers and capabilities.

DIMMING INFORMATION

DIM10 - 0-10V dimming on either MVOLT 120, 277. Dimmable down to 1% of initial lumens, standard. Available in 75W, 100W, 150W., 240W.
DIMTR - Electronic low voltage dimming. Available in 120V.
DALI - DALI DT6 dimming down to 1% Available in 75W, 100W, 150W, 240W.
EldoLED PowerDrive dimming down to 0.1%. Please see the EldoLED website for wiring diagrams and a full list of compatible DMX and DALI control systems.

FINISH

Luminaires are available in a powder-coated black or white post-paint finish. They may also be issued in custom RAL colors upon request. Consult the factory to find out which custom colors can be accommodated.

WARRANTY

Five-year warranty for parts and components.

SUSPENDED MOUNT TRACK OPTIONS

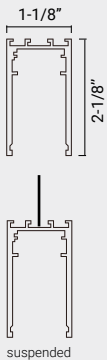
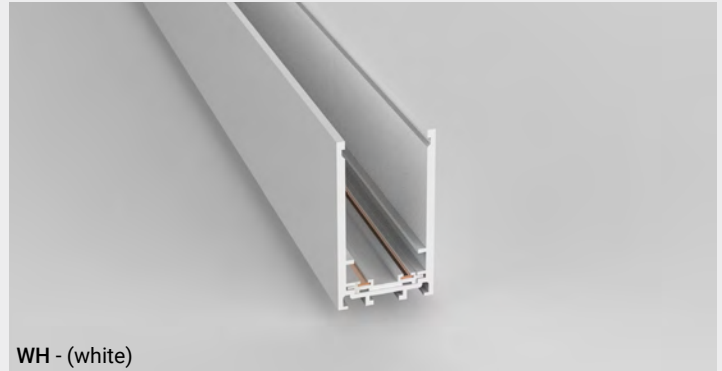
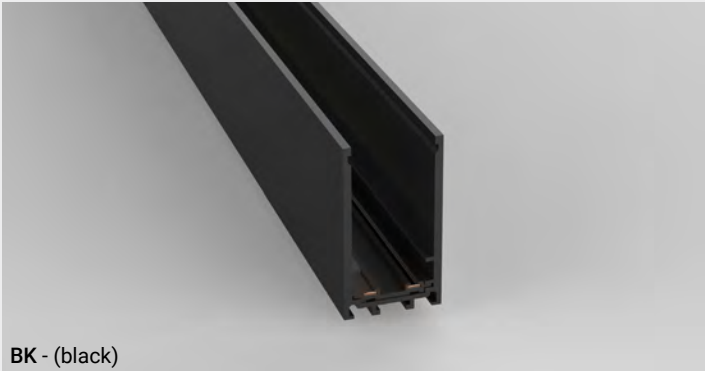

FG-SM--2 2 ft

FG-SM-4 4 ft

FG-SM-8 8 ft

TRACK CORNERS

● BK - (black) ○ WH - (white)

FG-CM-SM-ACC-2

"L" track Connector for Same Plane

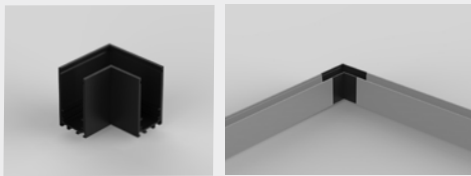
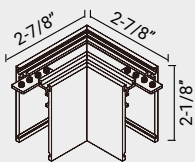

FG-CM-SM-ACC-5

"T" track Connector for Same Plane

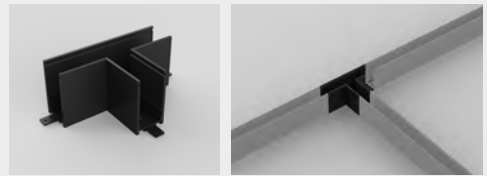
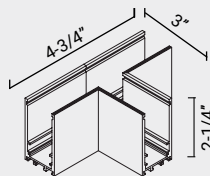

FG-CM-SM-ACC-3

"L" track Connector for inside corner of two surfaces

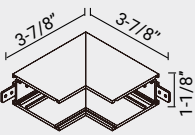

FG-CM-SM-ACC-6

"X" track Connector for inner corner of two surfaces

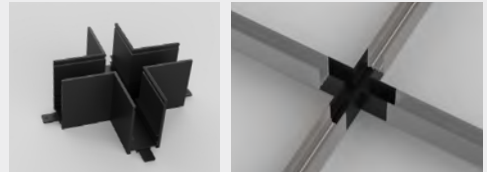
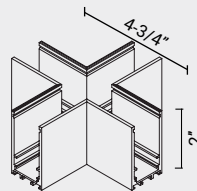

FG-CM-SM-ACC-4

"L" track Connector for outside corner of two surfaces

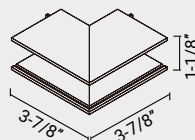

CORNERS EXAMPLE

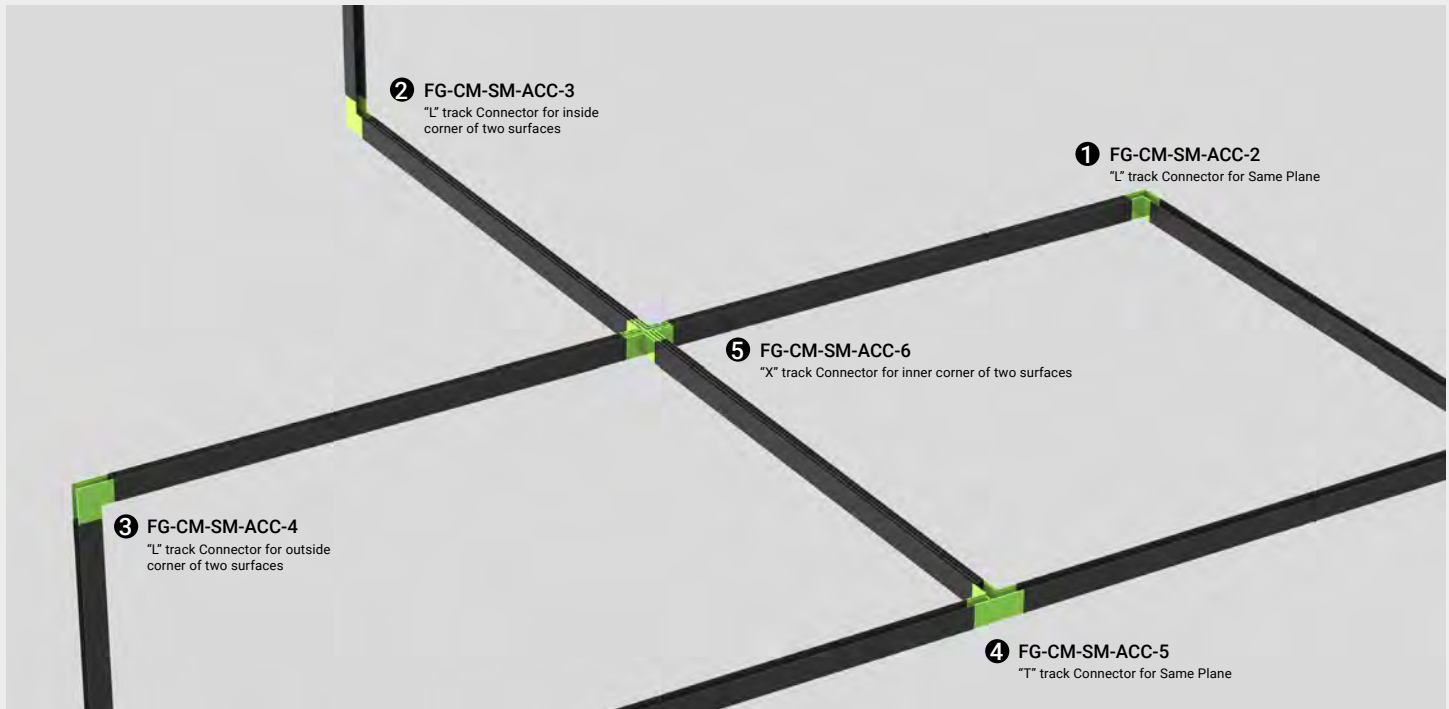

ACCESSORIES

● BK - (black) ○ WH - (white)

FG-ACC-1

Endcap (to close the open ends of tracks)

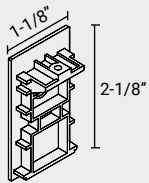

FG-ACC-2-2 (2')
FG-ACC-2-4 (4')
FG-ACC-2-8 (8')

Track Cover Cap (to avoid dust or decorate)

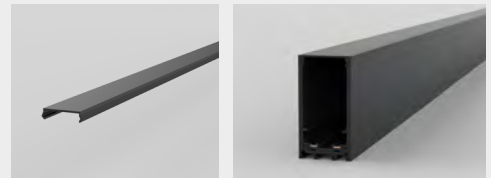
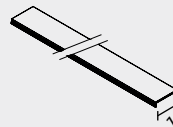

FG-SM-ACC-2

Suspended Hanging Wire (60")

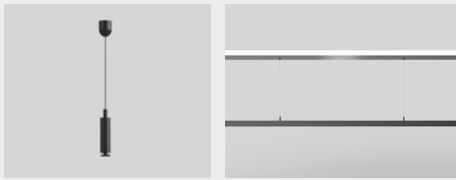
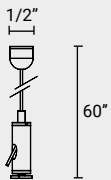

FG-SM-ACC-1

Suspended Tubular Hanging Wire (23")

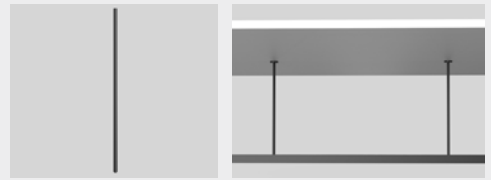
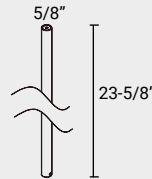

FG-SM-ACC-9

Track Connector

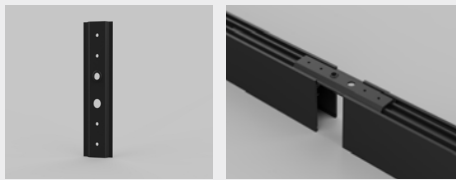

DRIVER CONNECTIONS

● BK - (black) ○ WH - (white)

Install the driver into ceiling or into the actual track with the following driver box options

FG-ACC-3

Live-end with cable

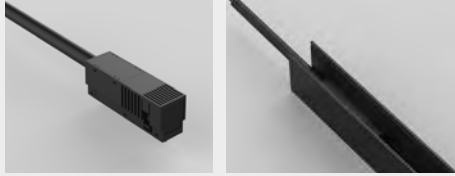
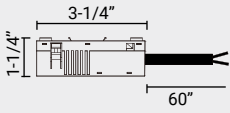

FG-ACC-4

Power Connector (Between Straight Tracks)

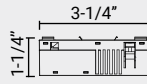

FG-ACC-5

Power Connector (flexible cable)

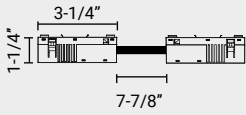

FG-ACC-5-L

Power Connector (flexible cable)

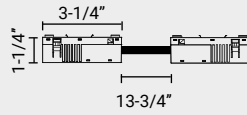

POWER TO THE CEILING:

Insert the cable of live-in accessory to connect power from the ceiling to the track.

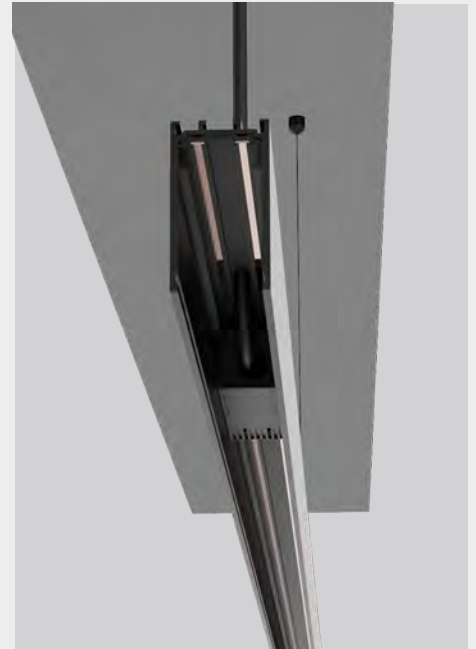

INTERNAL DRIVER OPTIONS (with box): ● BK - (black) ○ WH - (white)

Install the driver into ceiling or into the actual track with the following driver box options

FG-DI-200W-ON-OFF-48V

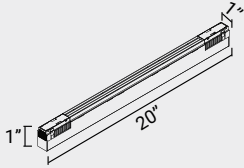

Voltage: 120V
Maximum Load: 200W
Dimming Option: Power ON/OFF

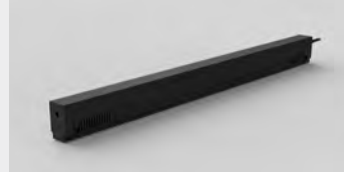

FG-DI-200W-10V-DIM-48V

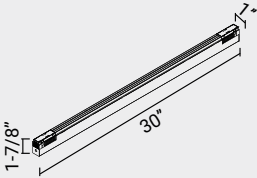

Voltage: 120V
Maximum Load: 200W
Dimming Option: 0-10V Dimmable



FG-DI-200W-DALI-48V

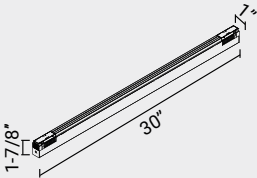

Voltage: 120V
Maximum Load: 200W
Dimming Option: Dali Dimmable



EXTERNAL DRIVER OPTIONS (with box):

PN: FG-DR-75W-48V

ELG-75 Series Constant Voltage + Constant Current Driver								
Model	Input Voltage	Output Voltage	Wattage (@120VAC)	Wattage (@277VAC)	Rated Current	Efficiency	Frequency	Power Factor (Normal)
ELG-75-48	120-277VAC 2	24-48V	60W	76.8W	1.6A	90%	50-60Hz	.9

0-10V & DALI dimming only

PN: FG-DR-100W-48V

ELG-100 Series Constant Voltage + Constant Current Driver								
Model	Input Voltage	Output Voltage	Wattage (@120VAC)	Wattage (@277VAC)	Rated Current	Efficiency	Frequency	Power Factor (Normal)
ELG-100-48	120-277VAC	24-48V	70W	96W	2A	90%	50-60Hz	.9

0-10V & DALI dimming only

EXTERNAL DRIVER OPTIONS:

PN: FG-DR-150W-48V

ELG-150 Series Constant Voltage + Constant Current Driver								
Model	Input Voltage	Output Voltage	Wattage * (@120VAC)	Wattage * (@277VAC)	Rated Current *	Efficiency *	Frequency	Power Factor (Normal)
ELG-150-48	120-277VAC	24-48V	105W	150W	3A	90%	50-60Hz	.9

0-10V & DALI dimming only
Type BE has different Wattage, Current & Efficiency See Chart Below

PN: FG-DR-200W-48V

ELG-200 Series Constant Voltage + Constant Current Driver								
Model	Input Voltage	Output Voltage	Wattage * (@120VAC)	Wattage * (@277VAC)	Rated Current *	Efficiency *	Frequency	Power Factor (Normal)
ELG-200-48	120-277VAC	24-48V	150W	200W	4.16A	93%	50-60Hz	.9

0-10V & DALI dimming only

PN: FG-DR-320W-48V

HLG-320 Series Constant Voltage + Constant Current Driver								
Model	Input Voltage	Output Voltage	Wattage * (@120VAC)	Wattage * (@277VAC)	Rated Current *	Efficiency *	Frequency	Power Factor (Normal)
HLG-320H-48	120-277VAC	24-48V	320W	320W	6A	95%	50-60Hz	.9

0-10V & DALI dimming only

PN: FG-DR-480W-48V

HLG-480 Series Constant Voltage + Constant Current Driver								
Model	Input Voltage	Output Voltage	Wattage * (@120VAC)	Wattage * (@277VAC)	Rated Current *	Efficiency *	Frequency	Power Factor (Normal)
HLG-480H-48	120-277VAC	24-48V	480W	480W	10A	94%	50-60Hz	.9

0-10V & DALI dimming only

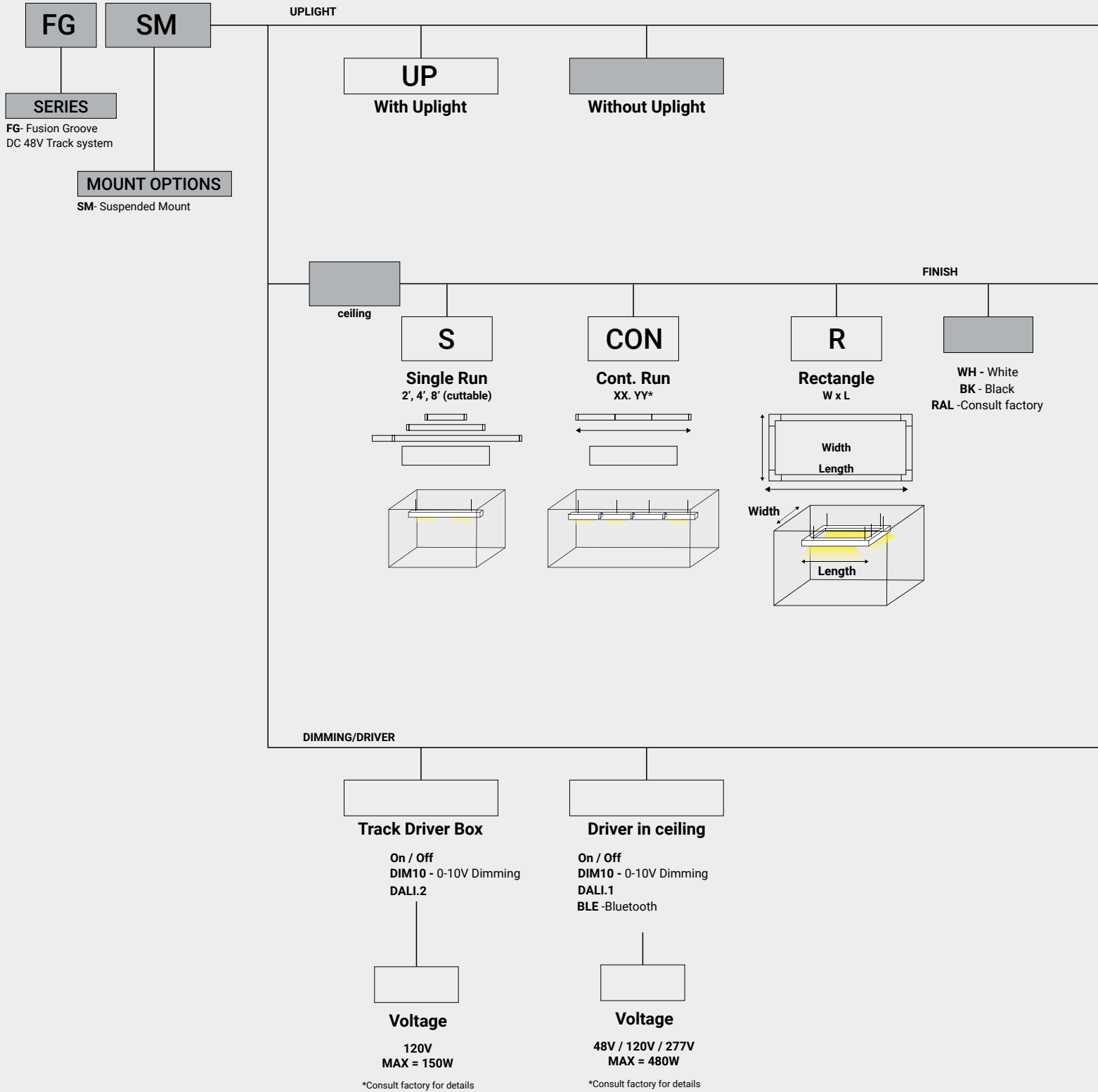



APPLICATIONS

The Groove 48V DC track system is available with multiple sleek, slender, and compact track heads that can be seamlessly mounted onto the track by simply clicking the track head's connector into place, allowing you to interchange one Groove-compatible luminaire for another. The Groove's intuitive click-in track makes it easy to install and switch luminaires, so the system can be updated to match any design or application, current or future.

The Groove track system is available in Trimless Recessed, Recessed Flanged, Ceiling/Surface, and Suspended options, and can be integrated in most ceiling and wall applications. Utilize suspended and surface mounting options for surface such as wood, drywall or T-Bar ceilings.

The Groove offers a variety of connector accessories that enable users to tailor their designs with custom rectangular, square, or many other linear patterns. The T, X, L Corners and power connectors create dynamic designs that transcend flat surfaces including wall to ceiling, wrap corners, and more.

Drivers can be stowed within the system, hidden from view, or placed in a remote location. The single driver can power runs up to 65' long and 480 Watts. Please refer to driver spec sheets for more detailed information. Our team at Elite Lighting can help you organize the placement of drivers and complete systems.

Fixtures can be installed individually or combined with other Groove track system luminaires to create the perfect design. Multiple linear fixtures can be mounted next to each other on one track for continuous rays of illumination.

Available track head options are in-line linear, adjustable linear, spot, pendant, cylinder, and suspended. Many track heads are crafted with black interiors and TIR optics, providing precise beam control and reducing glare. Most track heads that are available with optics are field-changeable, with various lumen and distribution options. Additionally, some track heads can be overlaid with a single optical accessory, like the Linear Diffuser, Frosted Diffuser, and Honeycomb accessories. Some track heads can be used with spot-light, flood-light, snoot, and wall-wash accessories. (Please refer to the spec sheet on each individual track head for more detailed information.)

Subsequently, the system can be used for accent, task, and general illumination, making it ideal for a plethora of applications, such as galleries, museums, hospitality spaces, retail spaces, corporate offices, and residential spaces.

CONSTRUCTION

All track heads are engineered to have an extremely long lifespan and service period by using coolLED's Advanced Thermodynamic Design, which includes an extruded aluminum body, a hidden diecast heat sink, and a thermal management system.

LED MODULE PERFORMANCE

The Groove System's luminaires are equipped with 2-step McAdam Eclipse LEDs, which provide consistent color across all fixtures, and 90+CRI. The LEDs are available in a variety of kelvin temperature options.

DRIVERS

The Groove System is powered by constant voltage drivers with a rating of 50/60Hz at a 120/277V input and a 48V output. They produce less than 20% THD, have a 90% power factor, and are thermally protected for additional safety. Driver wattages range from 75W to 450W and can power up to 65' of track. Groove drivers can be installed internally within the track or remotely mounted, and are available in 0-10V 1% Dimming, Dali Dimming, or 120V On/ Off Non-Dimming Driver. Please see Groove track system spec sheets for a complete list of drivers and capabilities.

DIMMING INFORMATION

DIM10 - 0-10V dimming on either MVOLT 120, 277. Dimmable down to 1% of initial lumens, standard. Available in 75W, 100W, 150W., 240W.
DIMTR - Electronic low voltage dimming. Available in 120V.
DALI - DALI DT6 dimming down to 1% Available in 75W, 100W, 150W, 240W.
EldoLED PowerDrive dimming down to 0.1%. Please see the EldoLED website for wiring diagrams and a full list of compatible DMX and DALI control systems.

FINISH

Luminaires are available in a powder-coated black or white post-paint finish. They may also be issued in custom RAL colors upon request. Consult the factory to find out which custom colors can be accommodated.

WARRANTY

Five-year warranty for parts and components.

SUSPENDED MOUNT TRACK OPTIONS

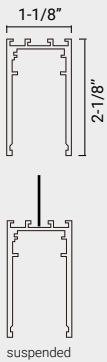
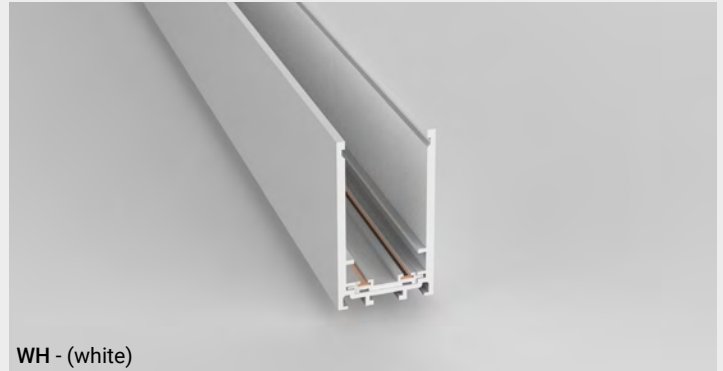
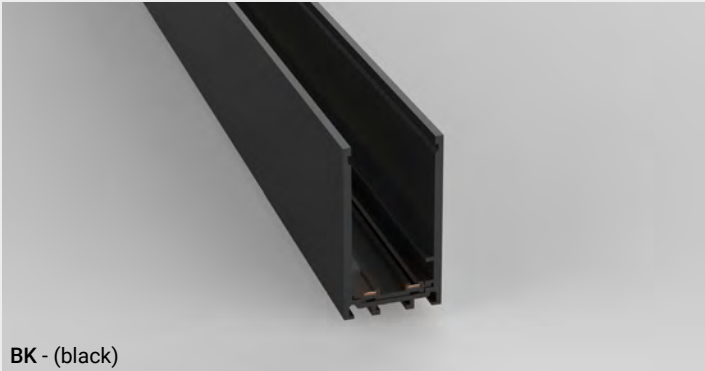

FG-SM-UP-2



FG-SM-UP-4

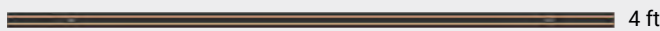

FG-SM-UP-8



TRACK CORNERS

● BK - (black) ○ WH - (white)

FG-CM-SM-ACC-2

"L" track Connector for Same Plane

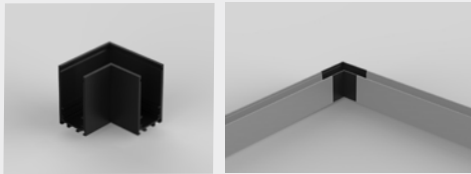
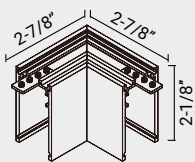

FG-CM-SM-ACC-5

"T" track Connector for Same Plane

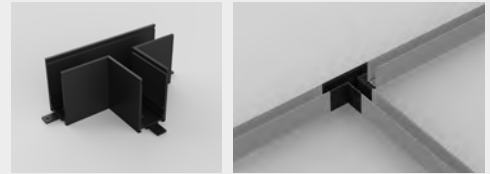
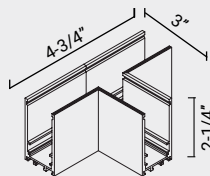

FG-CM-SM-ACC-3

"L" track Connector for inside corner of two surfaces

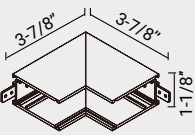

FG-CM-SM-ACC-6

"X" track Connector for inner corner of two surfaces

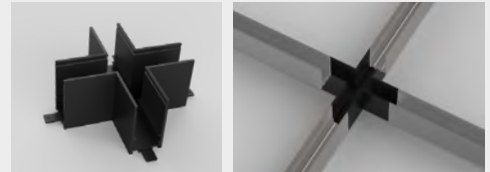
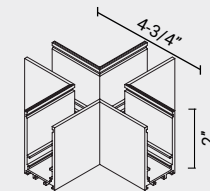

FG-CM-SM-ACC-4

"L" track Connector for outside corner of two surfaces

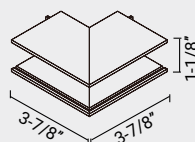

CORNERS EXAMPLE

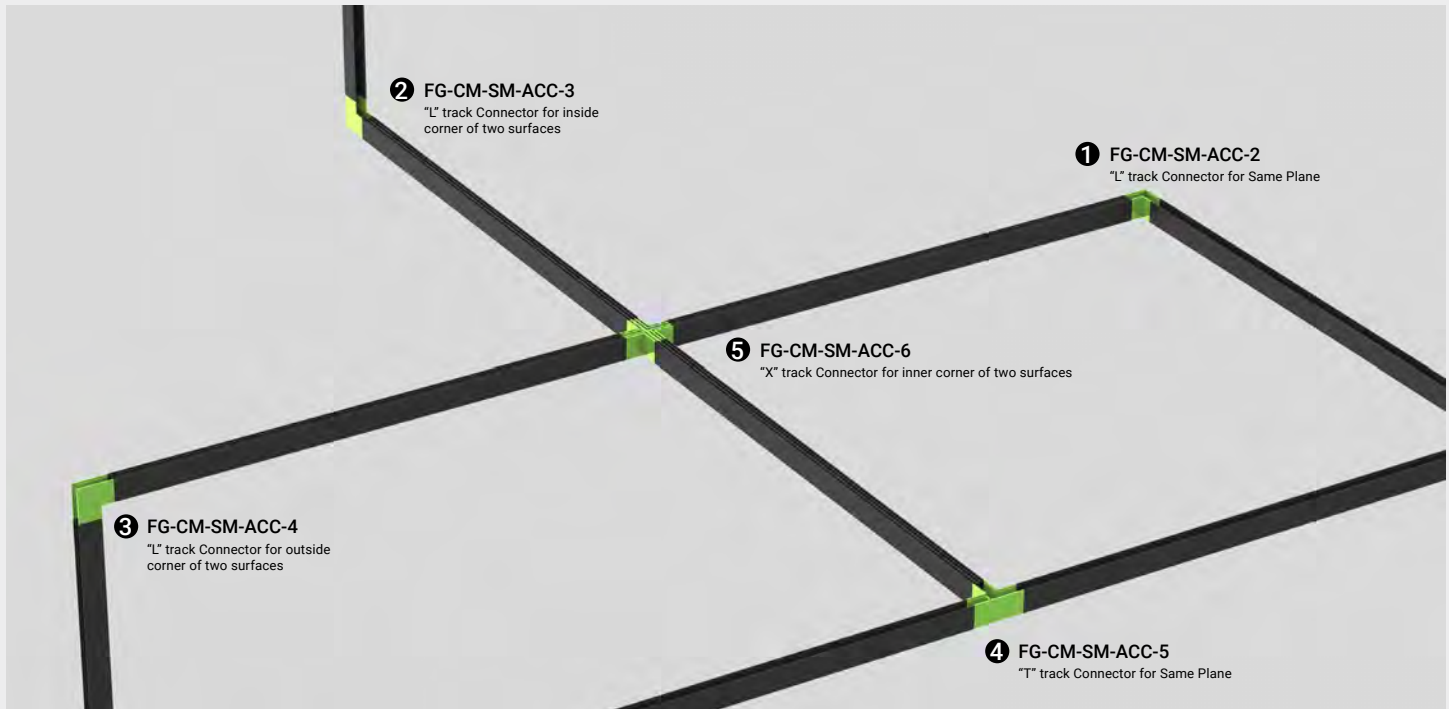

ACCESSORIES

● BK - (black) ○ WH - (white)

FG-ACC-1

Endcap (to close the open ends of tracks)

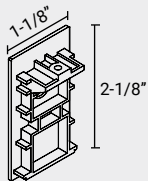

**FG-ACC-2-2 (2')
FG-ACC-2-4 (4')
FG-ACC-2-8 (8')**

Track Cover Cap (to avoid dust or decorate)

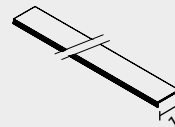

FG-SM-ACC-2

Suspended Hanging Wire (60")

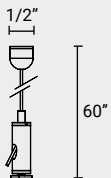

FG-SM-ACC-1

Suspended Tubular Hanging Wire (23")

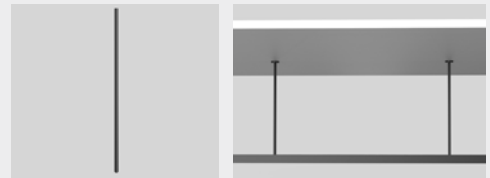
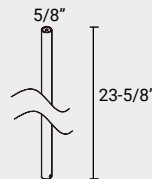

FG-SM-ACC-9

Track Connector

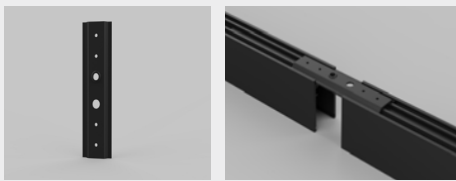

FG-ACC-4

Power Connector (Between Straight Tracks)



FG-ACC-3

Live-end with cable

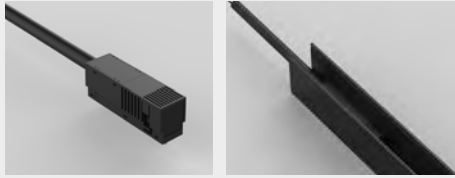
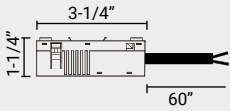

FG-ACC-3-5

Live-end for Uplight LED

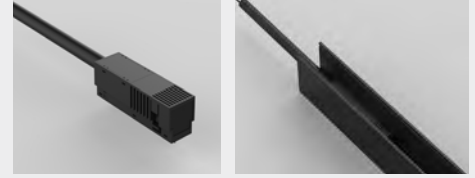
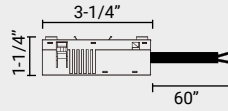

FG-ACC-5

Power Connector (flexible cable)

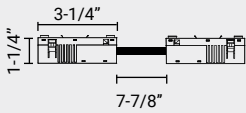

FG-ACC-5-L

Power Connector (flexible cable)

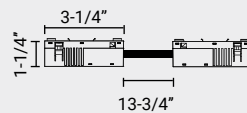

POWER TO THE CEILING:

Insert the cable of live-in accessory to connect power from the ceiling to the track.

Uplight Information:

LED: 1293 lm / 27-1/2"

System Lumen: 1200 lm / 27-1/2"

Power: 12.5W

Beam Angle: 110°

CCT Options: 2700K, 3000K, 3500K, 4000K, 5000K

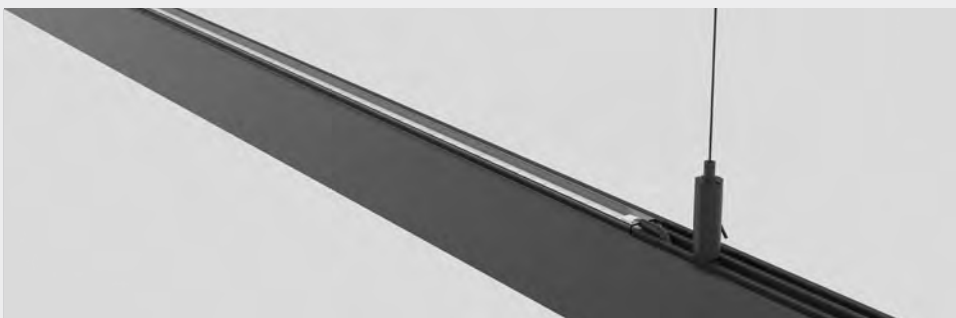

INTERNAL DRIVER OPTIONS (with box): ● BK - (black) ○ WH - (white)

Install the driver into ceiling or into the actual track with the following driver box options

FG-DI-200W-ON-OFF-48V

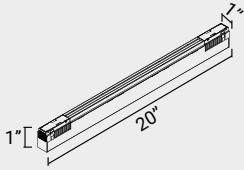

Voltage: 120V
Maximum Load: 200W
Dimming Option: Power ON/OFF



FG-DI-200W-10V-DIM-48V

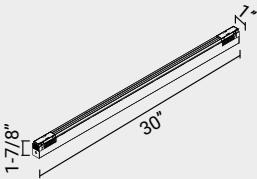

Voltage: 120V
Maximum Load: 200W
Dimming Option: 0-10V Dimmable



FG-DI-200W-DALI-48V

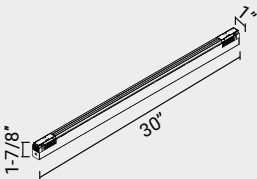

Voltage: 120V
Maximum Load: 200W
Dimming Option: Dali Dimmable

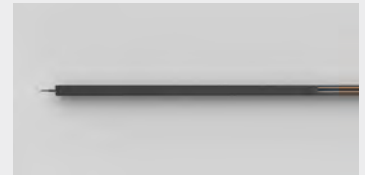

EXTERNAL DRIVER OPTIONS (with box):

PN: FG-DR-75W-48V

ELG-75 Series Constant Voltage + Constant Current Driver								
Model	Input Voltage	Output Voltage	Wattage (@120VAC)	Wattage (@277VAC)	Rated Current	Efficiency	Frequency	Power Factor (Normal)
ELG-75-48	120-277VAC 2	24-48V	60W	76.8W	1.6A	90%	50-60Hz	.9

0-10V & DALI dimming only

PN: FG-DR-100W-48V

ELG-100 Series Constant Voltage + Constant Current Driver								
Model	Input Voltage	Output Voltage	Wattage (@120VAC)	Wattage (@277VAC)	Rated Current	Efficiency	Frequency	Power Factor (Normal)
ELG-100-48	120-277VAC	24-48V	70W	96W	2A	90%	50-60Hz	.9

0-10V & DALI dimming only

EXTERNAL DRIVER OPTIONS:

PN: FG-DR-150W-48V

ELG-150 Series Constant Voltage + Constant Current Driver								
Model	Input Voltage	Output Voltage	Wattage * (@120VAC)	Wattage * (@277VAC)	Rated Current *	Efficiency *	Frequency	Power Factor (Normal)
ELG-150-48	120-277VAC	24-48V	105W	150W	3A	90%	50-60Hz	.9

0-10V & DALI dimming only
Type BE has different Wattage, Current & Efficiency See Chart Below

PN: FG-DR-200W-48V

ELG-200 Series Constant Voltage + Constant Current Driver								
Model	Input Voltage	Output Voltage	Wattage * (@120VAC)	Wattage * (@277VAC)	Rated Current *	Efficiency *	Frequency	Power Factor (Normal)
ELG-200-48	120-277VAC	24-48V	150W	200W	4.16A	93%	50-60Hz	.9

0-10V & DALI dimming only

PN: FG-DR-320W-48V

HLG-320 Series Constant Voltage + Constant Current Driver								
Model	Input Voltage	Output Voltage	Wattage * (@120VAC)	Wattage * (@277VAC)	Rated Current *	Efficiency *	Frequency	Power Factor (Normal)
HLG-320H-48	120-277VAC	24-48V	320W	320W	6A	95%	50-60Hz	.9

0-10V & DALI dimming only

PN: FG-DR-480W-48V

HLG-480 Series Constant Voltage + Constant Current Driver								
Model	Input Voltage	Output Voltage	Wattage * (@120VAC)	Wattage * (@277VAC)	Rated Current *	Efficiency *	Frequency	Power Factor (Normal)
HLG-480H-48	120-277VAC	24-48V	480W	480W	10A	94%	50-60Hz	.9

0-10V & DALI dimming only

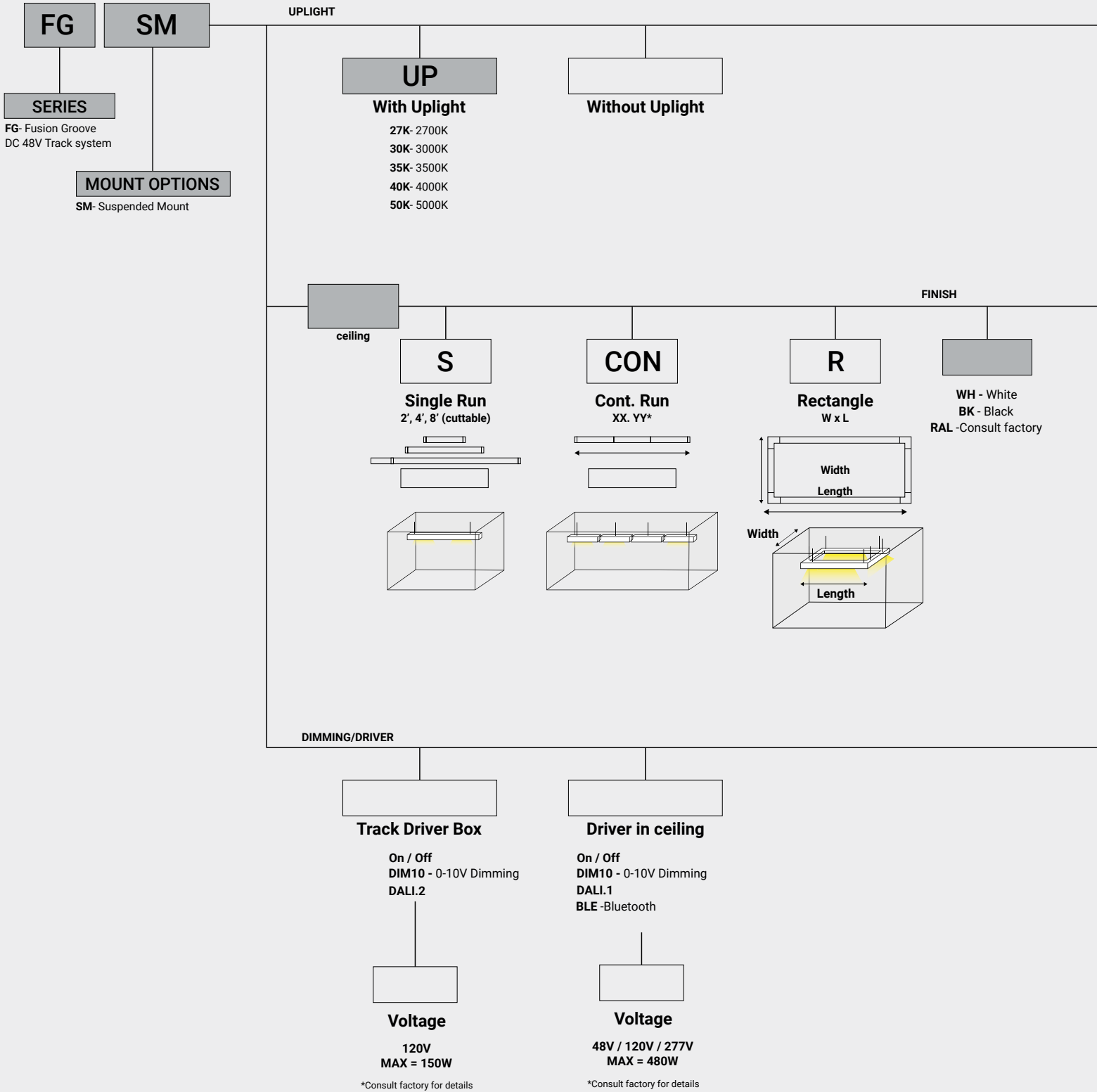



APPLICATIONS

The Groove 48V DC track system is available with multiple sleek, slender, and compact track heads that can be seamlessly mounted onto the track by simply clicking the track head's connector into place, allowing you to interchange one Groove-compatible luminaire for another. The Groove's intuitive click-in track makes it easy to install and switch luminaires, so the system can be updated to match any design or application, current or future.

The Groove track system is available in Trimless Recessed, Recessed Flanged, Ceiling/Surface, and Suspended options, and can be integrated in most ceiling and wall applications. Utilize suspended and surface mounting options for surface such as wood, drywall or T-Bar ceilings.

The Groove offers a variety of connector accessories that enable users to tailor their designs with custom rectangular, square, or many other linear patterns. The T, X, L Corners and power connectors create dynamic designs that transcend flat surfaces including wall to ceiling, wrap corners, and more.

Drivers can be stowed within the system, hidden from view, or placed in a remote location. The single driver can power runs up to 65' long and 480 Watts. Please refer to driver spec sheets for more detailed information. Our team at Elite Lighting can help you organize the placement of drivers and complete systems.

Fixtures can be installed individually or combined with other Groove track system luminaires to create the perfect design. Multiple linear fixtures can be mounted next to each other on one track for continuous rays of illumination.

Available track head options are in-line linear, adjustable linear, spot, pendant, cylinder, and suspended. Many track heads are crafted with black interiors and TIR optics, providing precise beam control and reducing glare. Most track heads that are available with optics are field-changeable, with various lumen and distribution options. Additionally, some track heads can be overlaid with a single optical accessory, like the Linear Diffuser, Frosted Diffuser, and Honeycomb accessories. Some track heads can be used with spot-light, flood-light, snoot, and wall-wash accessories. (Please refer to the spec sheet on each individual track head for more detailed information.)

Subsequently, the system can be used for accent, task, and general illumination, making it ideal for a plethora of applications, such as galleries, museums, hospitality spaces, retail spaces, corporate offices, and residential spaces.

CONSTRUCTION

All track heads are engineered to have an extremely long lifespan and service period by using coolLED's Advanced Thermodynamic Design, which includes an extruded aluminum body, a hidden diecast heat sink, and a thermal management system.

LED MODULE PERFORMANCE

The Groove System's luminaires are equipped with 2-step McAdam Eclipse LEDs, which provide consistent color across all fixtures, and 90+CRI. The LEDs are available in a variety of kelvin temperature options.

DRIVERS

The Groove System is powered by constant voltage drivers with a rating of 50/60Hz at a 120/277V input and a 48V output. They produce less than 20% THD, have a 90% power factor, and are thermally protected for additional safety. Driver wattages range from 75W to 450W and can power up to 65' of track. Groove drivers can be installed internally within the track or remotely mounted, and are available in 0-10V 1% Dimming, Dali Dimming, or 120V On/ Off Non-Dimming Driver. Please see Groove track system spec sheets for a complete list of drivers and capabilities.

DIMMING INFORMATION

DIM10 - 0-10V dimming on either MVOLT 120, 277. Dimmable down to 1% of initial lumens, standard. Available in 75W, 100W, 150W, 240W.
DIMTR - Electronic low voltage dimming. Available in 120V.
DALI - DALI DT6 dimming down to 1% Available in 75W, 100W, 150W, 240W.
EldoLED PowerDrive dimming down to 0.1%. Please see the EldoLED website for wiring diagrams and a full list of compatible DMX and DALI control systems.

FINISH

Luminaires are available in a powder-coated black or white post-paint finish. They may also be issued in custom RAL colors upon request. Consult the factory to find out which custom colors can be accommodated.

WARRANTY

Five-year warranty for parts and components.

Suspended Mount Direct/Indirect Track Option A:

● BK - (black) ○ WH - (white)

*A hole for the up & down power connector

*Up & down power connector is included and movable

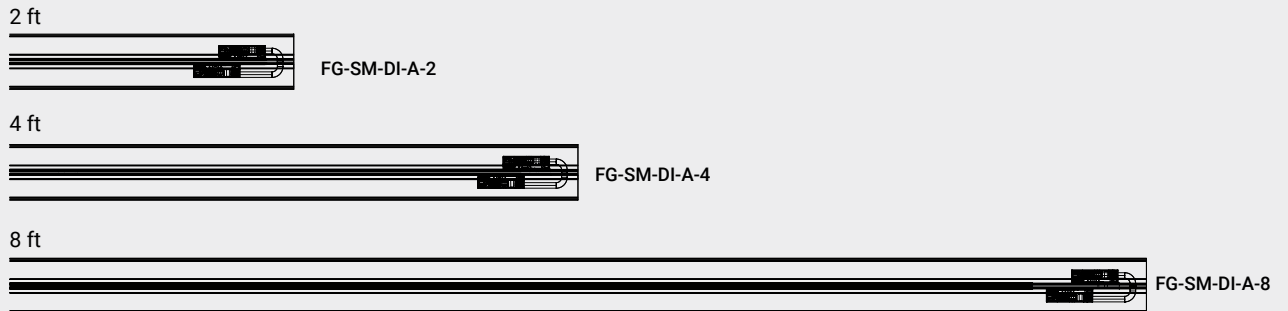
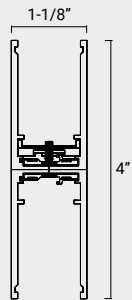
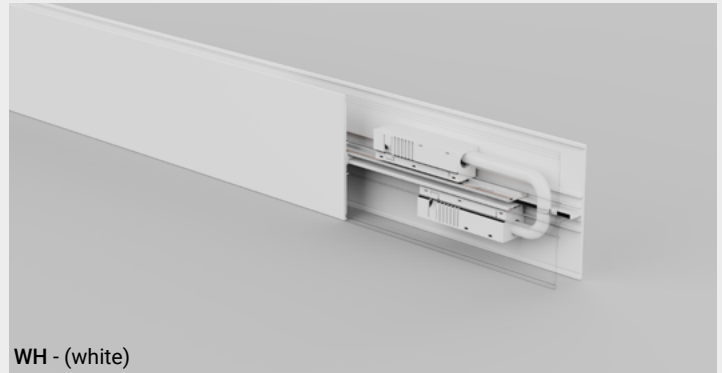
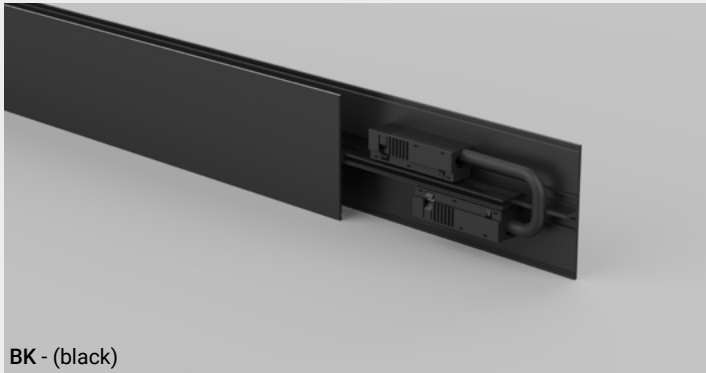

Suspended Mount Direct/Indirect Track Option B:

● BK - (black) ○ WH - (white)

*Regular up & down track without the hole.

*Needs to combine with Track Option A to feed power for the down track.

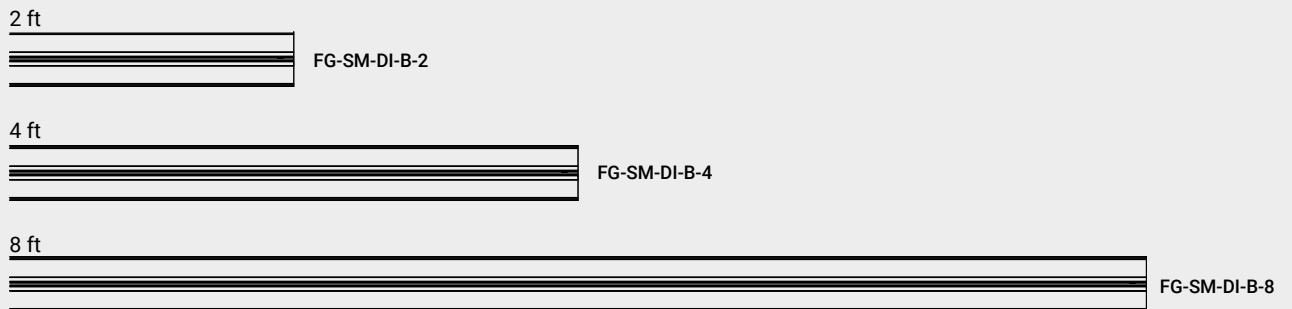
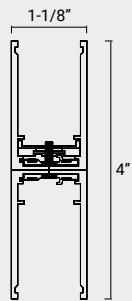
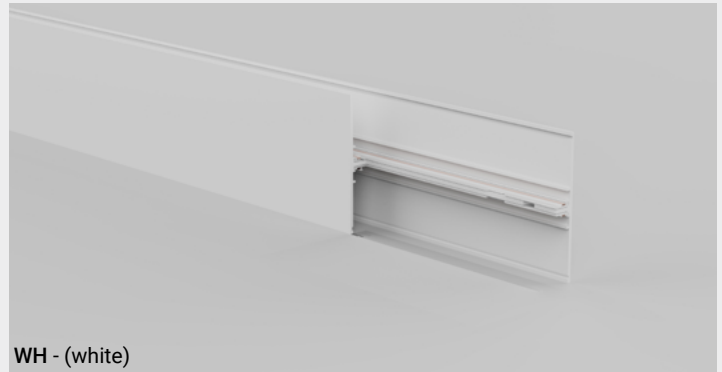
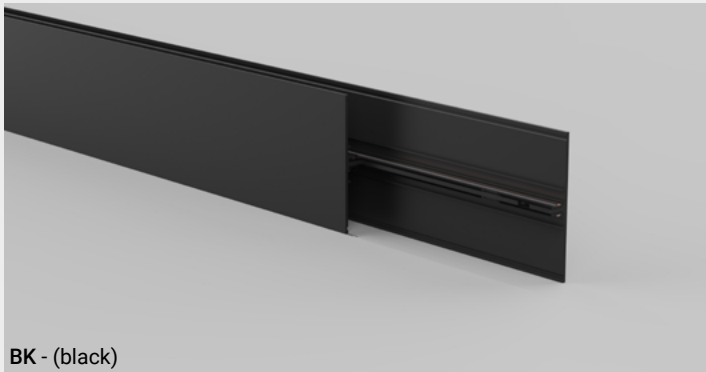

TRACK CORNERS

● BK - (black) ○ WH - (white)

FG-SM-DI-ACC-2

"L" track Connector for Same Plane

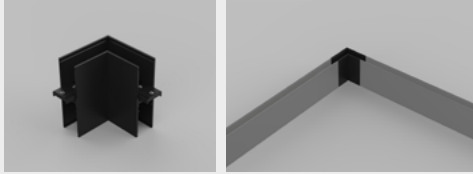
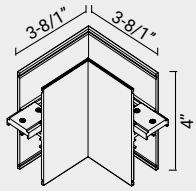

FG-SM-DI-ACC-5

"T" track Connector for Same Plane

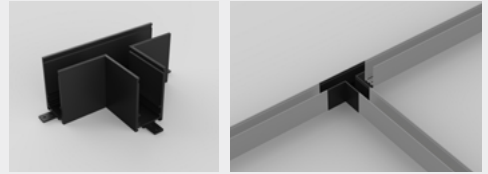
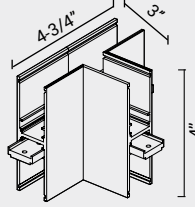

FG-SM-DI-ACC-3

"L" track Connector for inside corner of two surfaces

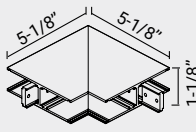

FG-SM-DI-ACC-6

"X" track Connector for inner corner of two surfaces

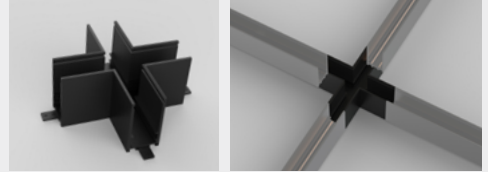
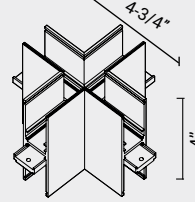

FG-SM-DI-ACC-4

"L" track Connector for outside corner of two surfaces

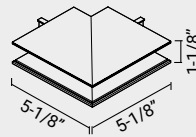

CORNERS EXAMPLE

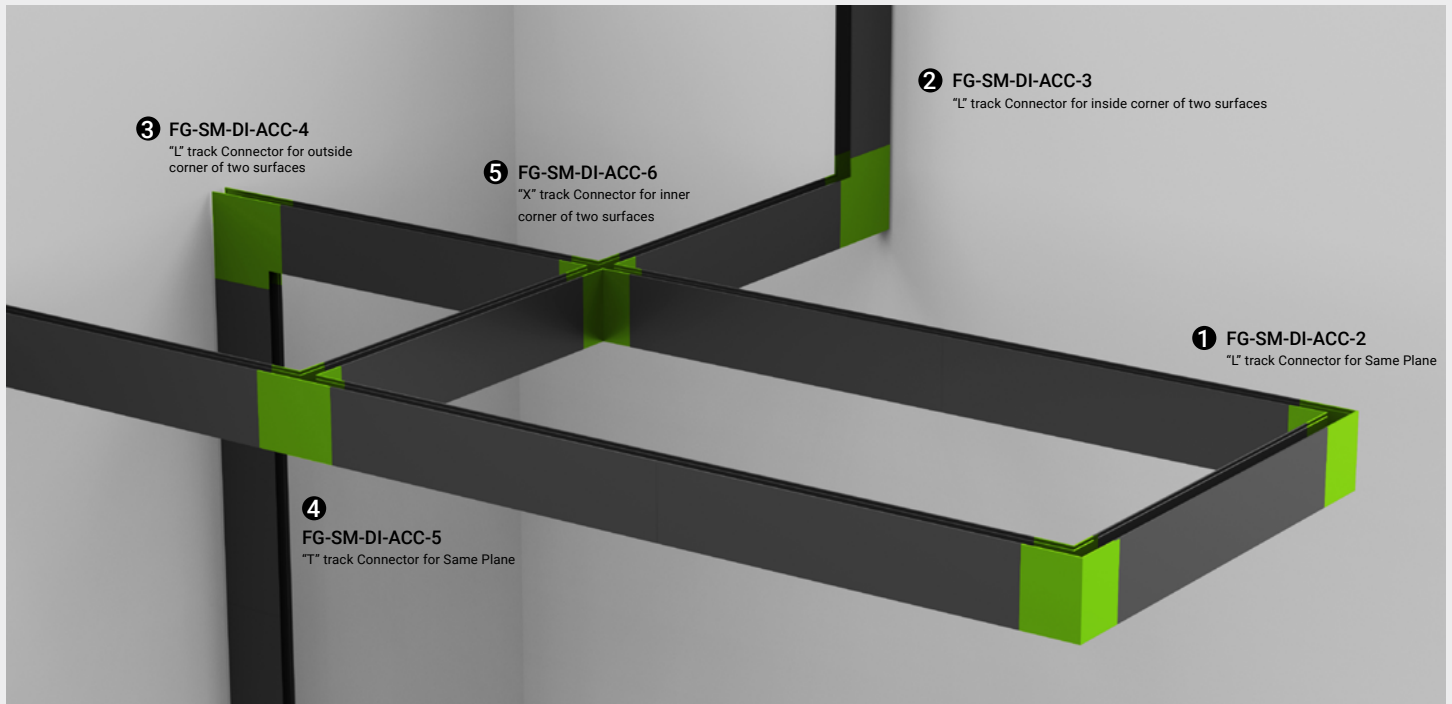

③ FG-SM-DI-ACC-4
"L" track Connector for outside corner of two surfaces

⑤ FG-SM-DI-ACC-6
"X" track Connector for inner corner of two surfaces

② FG-SM-DI-ACC-3
"L" track Connector for inside corner of two surfaces

① FG-SM-DI-ACC-2
"L" track Connector for Same Plane

④ FG-SM-DI-ACC-5
"T" track Connector for Same Plane

ACCESSORIES

● BK - (black) ○ WH - (white)

FG-ACC-1

Endcap (*2 for each DI track end)

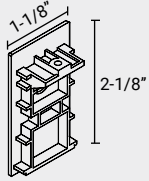

FG-ACC-2-2 (2')
FG-ACC-2-4 (4')
FG-ACC-2-8 (8')

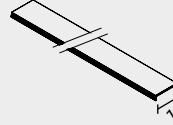

Track Cover Cap (to avoid dust or decorate)



FG-ACC-3-1C

Live-end with cable (opposite direction for up track)

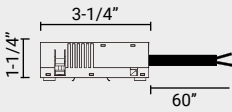

DO NOT SLIDE IT INTO THE TRACK.

FG-ACC-4

Power Connector (Between Straight Down Tracks)

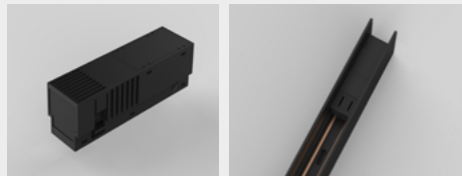
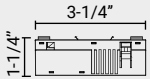

DO NOT SLIDE IT INTO THE TRACK.

FG-ACC-5

Power Connector (for Corners and Up Straight Tracks)

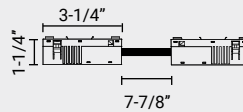

DO NOT SLIDE IT INTO THE TRACK.

FG-ACC-5-L

Power Connector for "T" Corners (flexible cable)

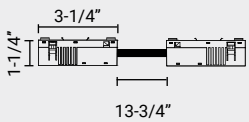

DO NOT SLIDE IT INTO THE TRACK.

FG-ACC-5-2

Up & Down power connector (included in A Track)

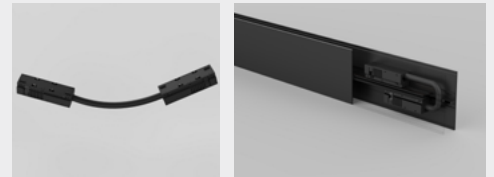
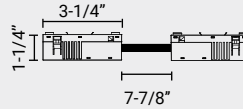

DO NOT SLIDE IT INTO THE TRACK.

FG-SM-DI-ACC-7

Adapter Cap (direction translator for FG-ACC-3/5)

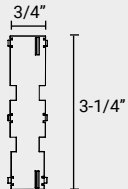

FG-SM-DI-ACC-9

Track Physical Connector

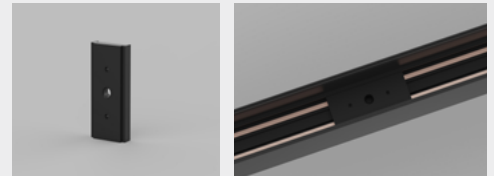
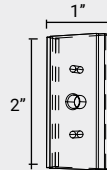

Hanging Wire

● BK - (black) ○ CH - (Chrome)

FG-SM-DI-ACC-1

Suspended Hanging Wire (59")

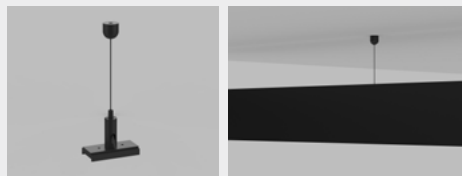
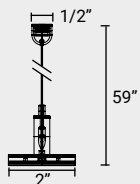

INTERNAL DRIVER OPTIONS (with box):

● BK - (black) ○ WH - (white)

Install the driver into ceiling or into the actual track with the following driver box options
*please be careful about the current direction when using the internal driver.

FG-DI-200W-ON-OFF-48V

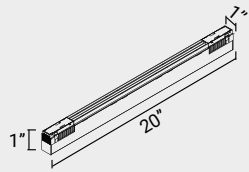

Voltage: 120V
Maximum Load: 200W
Dimming Option: Power ON/OFF

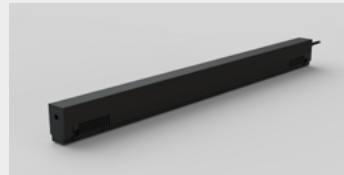

FG-DI-200W-10V-DIM-48V

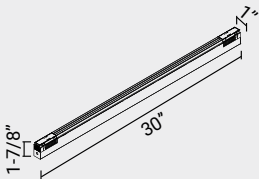

Voltage: 120V
Maximum Load: 200W
Dimming Option: 0-10V Dimmable

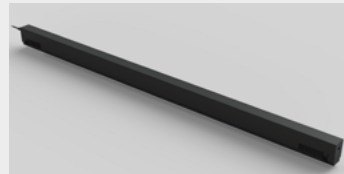

FG-DI-200W-DALI-48V

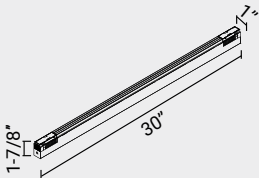

Voltage: 120V
Maximum Load: 200W
Dimming Option: Dali Dimmable

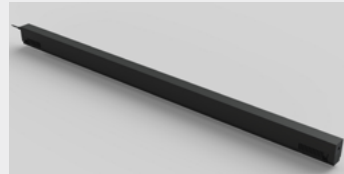

EXTERNAL DRIVER OPTIONS (with box):

FG-DR-75W-ON-OFF-48V | FG-DR-75W-10V-DIM-48V | FG-DR-75W-DALI-48V

FG-DR-75W-48V Series Constant Voltage + Constant Current Driver								
Model	Input Voltage	Output Voltage	Wattage (@120VAC)	Wattage (@277VAC)	Rated Current	Efficiency	Frequency	Power Factor (Normal)
FG-DR-75W-48V	120-277VAC 2	24-48V	60W	76.8W	1.6A	90%	50-60Hz	.9

0-10V & DALI dimming only

FG-DR-100W-ON-OFF-48V | FG-DR-100W-10V-DIM-48V | FG-DR-100W-DALI-48V

FG-DR-100W-48V Series Constant Voltage + Constant Current Driver								
Model	Input Voltage	Output Voltage	Wattage (@120VAC)	Wattage (@277VAC)	Rated Current	Efficiency	Frequency	Power Factor (Normal)
FG-DR-100W-48V	120-277VAC	24-48V	70W	96W	2A	90%	50-60Hz	.9

0-10V & DALI dimming only

EXTERNAL DRIVER OPTIONS:

FG-DR-150W-ON-OFF-48V | FG-DR-150W-10V-DIM-48V | FG-DR-150W-DALI-48V

FG-DR-150W-48V Series Constant Voltage + Constant Current Driver								
Model	Input Voltage	Output Voltage	Wattage * (@120VAC)	Wattage * (@277VAC)	Rated Current *	Efficiency *	Frequency	Power Factor (Normal)
FG-DR-150W-48V	120-277VAC	24-48V	105W	150W	3A	90%	50-60Hz	.9

0-10V & DALI dimming only

Type BE has different Wattage, Current & Efficiency See Chart Below

FG-DR-200W-ON-OFF-48V | FG-DR-200W-10V-DIM-48V | FG-DR-200W-DALI-48V

FG-DR-200W-48V Series Constant Voltage + Constant Current Driver								
Model	Input Voltage	Output Voltage	Wattage * (@120VAC)	Wattage * (@277VAC)	Rated Current *	Efficiency *	Frequency	Power Factor (Normal)
FG-DR-200W-48V	120-277VAC	24-48V	150W	200W	4.16A	93%	50-60Hz	.9

0-10V & DALI dimming only

FG-DR-320W-ON-OFF-48V | FG-DR-320W-10V-DIM-48V | FG-DR-320W-DALI-48V

FG-DR-320W-48V Series Constant Voltage + Constant Current Driver								
Model	Input Voltage	Output Voltage	Wattage * (@120VAC)	Wattage * (@277VAC)	Rated Current *	Efficiency *	Frequency	Power Factor (Normal)
FG-DR-320W-48V	120-277VAC	24-48V	320W	320W	6A	95%	50-60Hz	.9

0-10V & DALI dimming only

FG-DR-480W-ON-OFF-48V | FG-DR-480W-10V-DIM-48V | FG-DR-480W-DALI-48V

FG-DR-480W-48V Series Constant Voltage + Constant Current Driver								
Model	Input Voltage	Output Voltage	Wattage * (@120VAC)	Wattage * (@277VAC)	Rated Current *	Efficiency *	Frequency	Power Factor (Normal)
FG-DR-480W-48V	120-277VAC	24-48V	480W	480W	10A	94%	50-60Hz	.9

0-10V & DALI dimming only

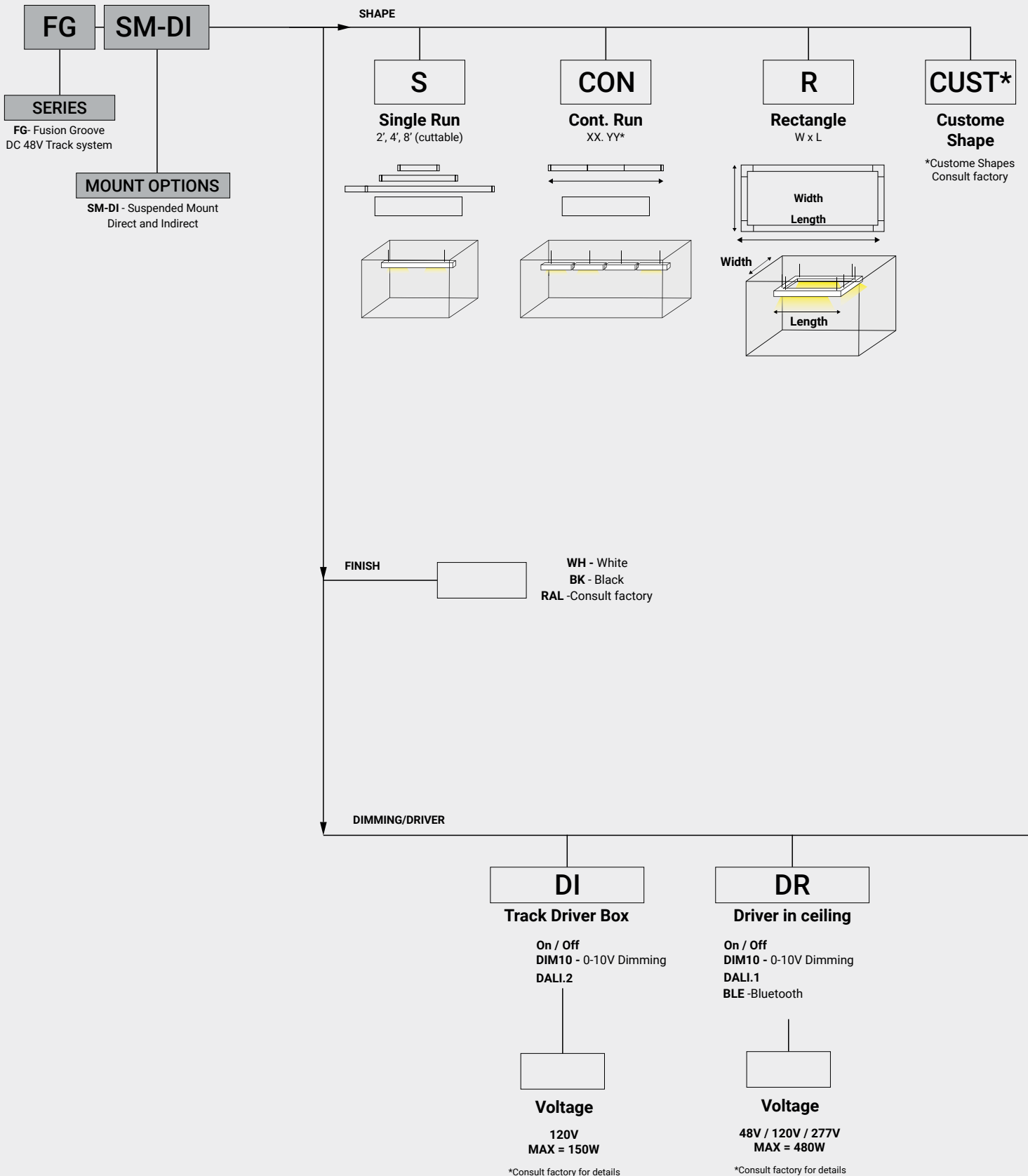

Typical Configuration Design Examples:

*These examples are for the concept understanding, please consult order@iuseelite.com for customize service.

FG-SM-DI-S-BK-DR-DIM10

E.g. 1: Groove Suspended Mount Direct/Indirect 8' track in black with 150W 0-10V dimming remote driver:

Keywords: Single Track / 1 Circuit / Remote Driver

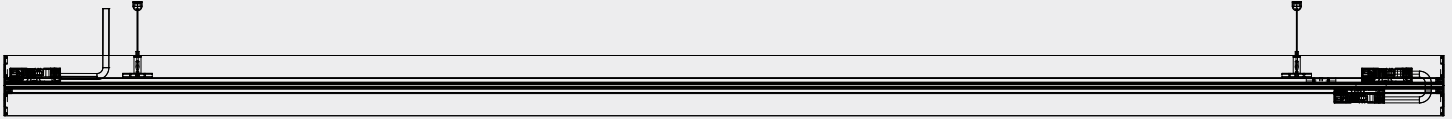

Part Number	Quantity	Description	Category
FG-SM-DI-A-8-BK	1	8' FG-SM-DI A Track in Black	Track
FG-ACC-1-BK	4	Endcaps	
FG-SM-DI-ACC-1-BK	2	Suspended Hanging Wire in Black	Mounting
FG-ACC-3-1C-BK	1	Live End Opposite Direction (power connector from the driver to the up track)	Power Accessory
FG-DR-150W-10V-DIM-48V	1	150W 0-10V Dimming Remote Driver	Driver

FG-SM-DI-CON-4.4-BK-DR-DIM10

E.g. 2: Groove Suspended Mount Direct/Indirect Continuous 8' track in black with 1 circuit 200W 0-10V dimming remote driver:

Keywords: Continuous Tracks / 1 Circuit / Remote Driver

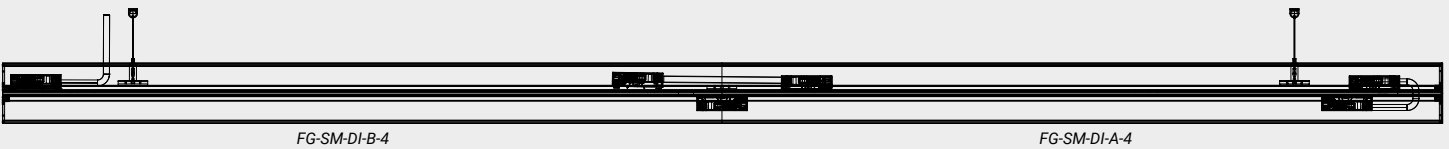

Part Number	Quantity	Description	Category
FG-SM-DI-A-4-BK	1	4' FG-SM-DI A Track in Black	Track
FG-SM-DI-B-4-BK	1	4' FG-SM-DI B Track in Black	
FG-ACC-1-BK	4	Endcaps	Mounting
FG-SM-DI-ACC-1-BK	2	Suspended Hanging Wire in Black	
FG-ACC-4-BK	1	Power Connector (between straight down tracks) in Black	Track Connection
FG-ACC-5-BK	1	Power Connector (for corners and up straight tracks) in Black	
FG-SM-DI-ACC-9	1	Track Physical Connector	
FG-ACC-3-1C-BK	1	Live End Opposite Direction (power connector from the driver to the up track)	Power Accessory
FG-DR-200W-10V-DIM-48V	1	200W 0-10V Dimming Remote Driver	Driver

Typical Configuration Design Examples:

*These examples are for the concept understanding, please consult order@iuseelite.com for customize service.

FG-SM-DI-R-4X4-BK-DR-DIM10

E.g. 5: Groove Suspended Mount Direct/Indirect 4'x4' Rectangle in black with 1 circuit 320W 0-10V dimming remote driver:

Keywords: Rectangle / 4'x4' / 1 Circuit / Remote Driver

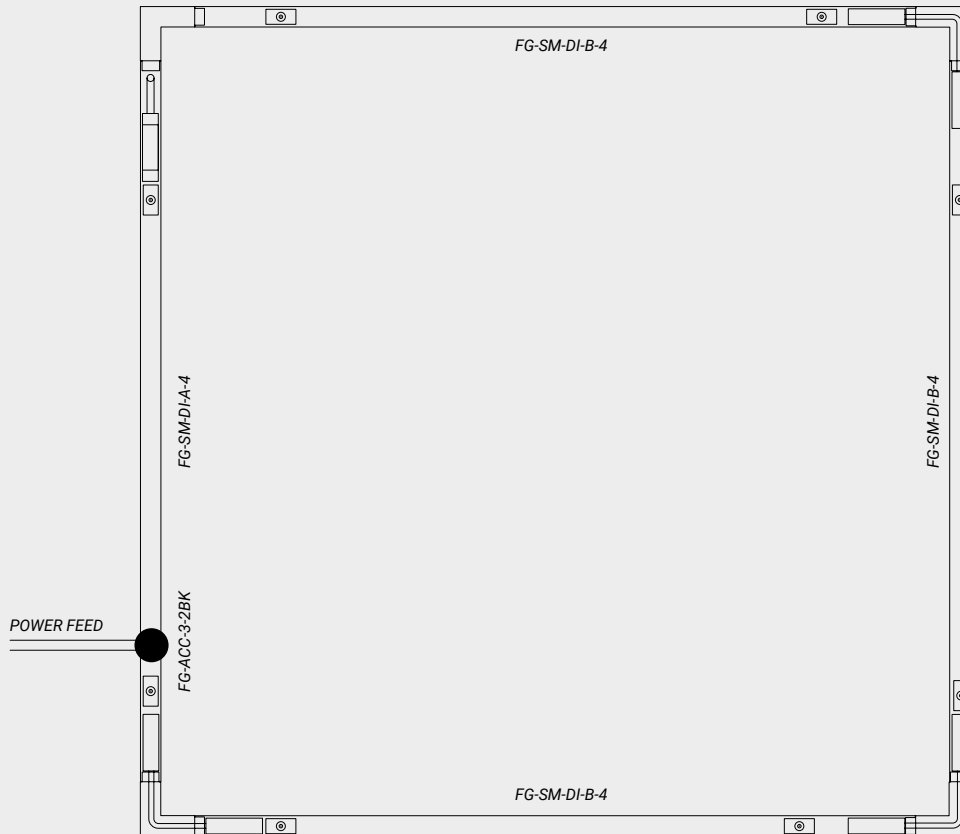

Part Number	Quantity	Description	Category
FG-SM-DI-A-4-BK	1	4' FG-SM-DI A Track in Black	Track
FG-SM-DI-B-4-BK	3	4' FG-SM-DI B Track in Black	
FG-SM-DI-ACC-2-BK	4	"L" Track Corner Connector for Same Plane in Black	Corner
FG-SM-DI-ACC-1-BK	8	Suspended Hanging Wire in Black	Mounting
FG-ACC-5-BK	6	Power Connector (for corners and up straight tracks) in Black	Power Accessory
FG-ACC-3-1C-BK	1	Live End Opposite Direction (power connector from the driver to the up track)	
FG-DR-320W-10V-DIM-48V	1	320W 0-10V Dimming Remote Driver	Driver



APPLICATIONS

The Groove 48V DC track system is available with multiple sleek, slender, and compact track heads that can be seamlessly mounted onto the track by simply clicking the track head's connector into place, allowing you to interchange one Groove-compatible luminaire for another. The Groove's intuitive click-in track makes it easy to install and switch luminaires, so the system can be updated to match any design or application, current or future.

The Groove track system is available in Trimless Recessed, Recessed Flanged, Ceiling/Surface, and Suspended options, and can be integrated in most ceiling and wall applications. Utilize suspended and surface mounting options for surface such as wood, drywall or T-Bar ceilings.

The Groove offers a variety of connector accessories that enable users to tailor their designs with custom rectangular, square, or many other linear patterns. The T, X, L Corners and power connectors create dynamic designs that transcend flat surfaces including wall to ceiling, wrap corners, and more.

Drivers can be stowed within the system, hidden from view, or placed in a remote location. The single driver can power runs up to 65' long and 480 Watts. Please refer to driver spec sheets for more detailed information. Our team at Elite Lighting can help you organize the placement of drivers and complete systems.

Fixtures can be installed individually or combined with other Groove track system luminaires to create the perfect design. Multiple linear fixtures can be mounted next to each other on one track for continuous rays of illumination.

Available track head options are in-line linear, adjustable linear, spot, pendant, cylinder, and suspended. Many track heads are crafted with black interiors and TIR optics, providing precise beam control and reducing glare. Most track heads that are available with optics are field-changeable, with various lumen and distribution options. Additionally, some track heads can be overlaid with a single optical accessory, like the Linear Diffuser, Frosted Diffuser, and Honeycomb accessories. Some track heads can be used with spot-light, flood-light, snoot, and wall-wash accessories. (Please refer to the spec sheet on each individual track head for more detailed information.)

Subsequently, the system can be used for accent, task, and general illumination, making it ideal for a plethora of applications, such as galleries, museums, hospitality spaces, retail spaces, corporate offices, and residential spaces.

CONSTRUCTION

All track heads are engineered to have an extremely long lifespan and service period by using coolLED's Advanced Thermodynamic Design, which includes an extruded aluminum body, a hidden diecast heat sink, and a thermal management system.

LED MODULE PERFORMANCE

The Groove System's luminaires are equipped with 2-step McAdam Eclipse LEDs, which provide consistent color across all fixtures, and 90+CRI. The LEDs are available in a variety of kelvin temperature options.

DRIVERS

The Groove System is powered by constant voltage drivers with a rating of 50/60Hz at a 120/277V input and a 48V output. They produce less than 20% THD, have a 90% power factor, and are thermally protected for additional safety. Driver wattages range from 75W to 450W and can power up to 65' of track. Groove drivers can be installed internally within the track or remotely mounted, and are available in 0-10V 1% Dimming, Dali Dimming, or 120V On/ Off Non-Dimming Driver. Please see Groove track system spec sheets for a complete list of drivers and capabilities.

DIMMING INFORMATION

DIM10 - 0-10V dimming on either MVOLT 120, 277. Dimmable down to 1% of initial lumens, standard. Available in 75W, 100W, 150W, 240W.

DIMTR - Electronic low voltage dimming. Available in 120V.

DALI - DALI DT6 dimming down to 1% Available in 75W, 100W, 150W, 240W.

EldoLED PowerDrive dimming down to 0.1%. Please see the EldoLED website for wiring diagrams and a full list of compatible DMX and DALI control systems.

FINISH

Luminaires are available in a powder-coated black or white post-paint finish. They may also be issued in custom RAL colors upon request. Consult the factory to find out which custom colors can be accommodated.

WARRANTY

Five-year warranty for parts and components.

NOTE: 2 Circuits allow to control the up & down tracks, instead of different fixtures, separately.

Suspended Mount Direct/Indirect Track Option A:

● BK - (black) ○ WH - (white)

*A hole for the up & down power connector

*please take off the included power connector for 2 circuits.

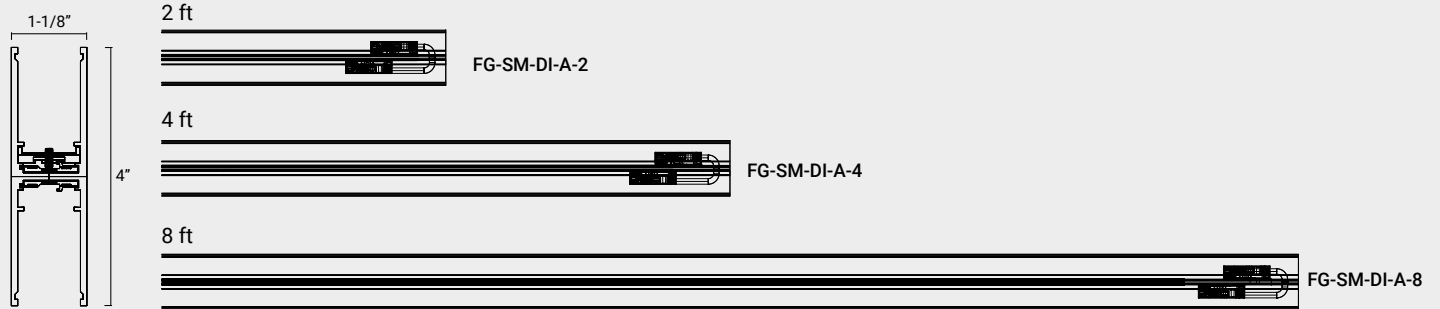
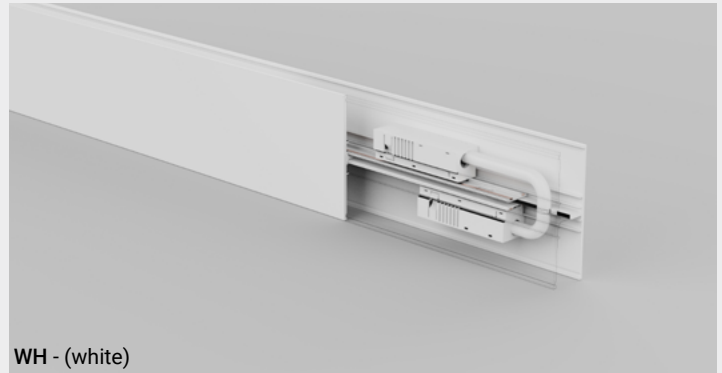
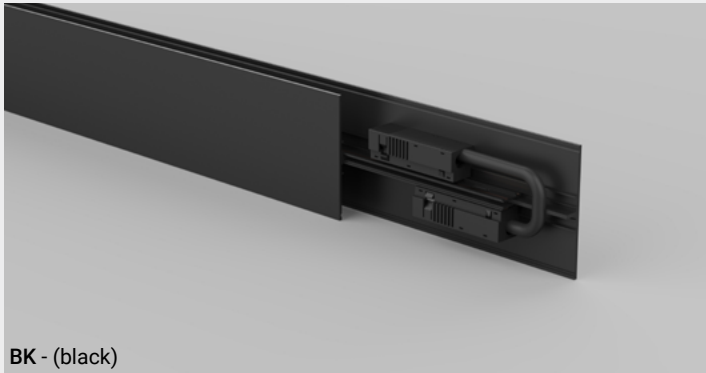

Suspended Mount Direct/Indirect Track Option B:

● BK - (black) ○ WH - (white)

*Regular up & down track without the hole.

*Needs to combine with Track Option A to feed power for the down track.

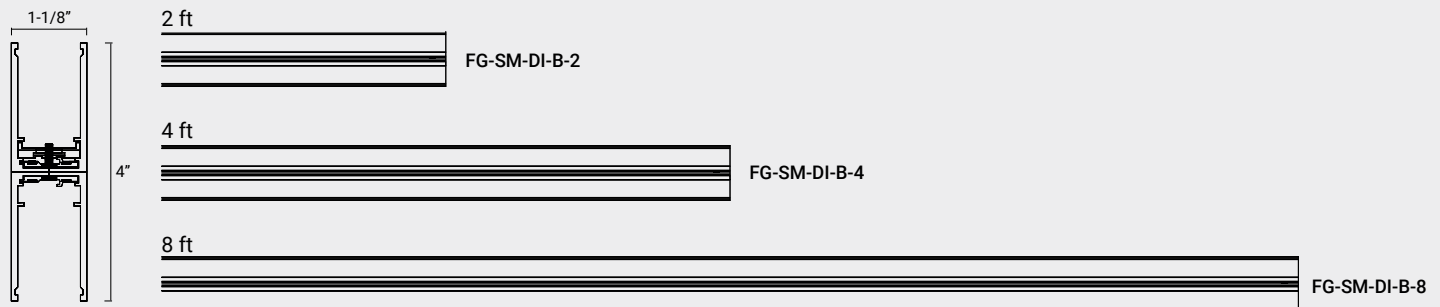
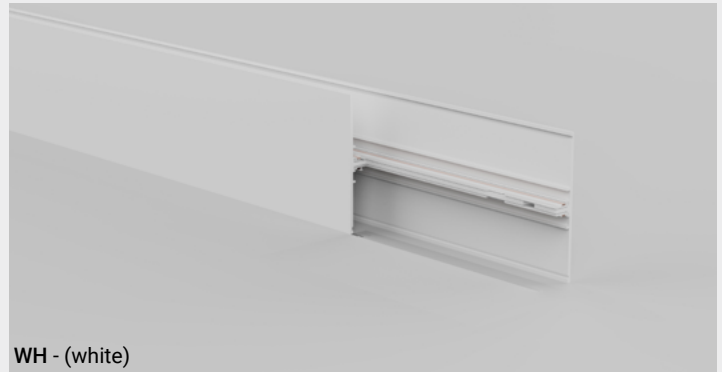
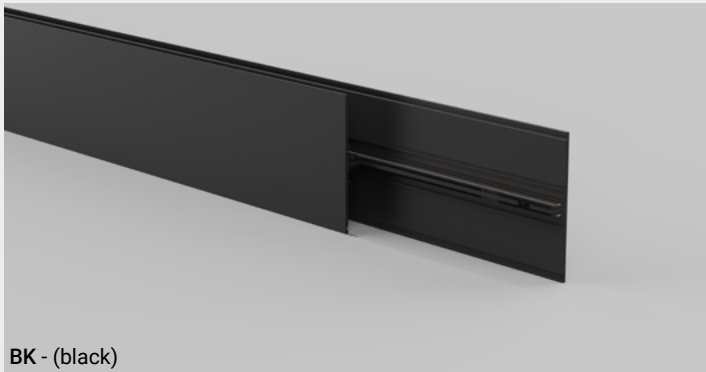

TRACK CORNERS

● BK - (black) ○ WH - (white)

*for separate control, please take off the included connector in track A to install FG-ACC-3 for power connection of the down track when using the corners for different configurations.

FG-SM-DI-ACC-2

"L" track Connector for Same Plane

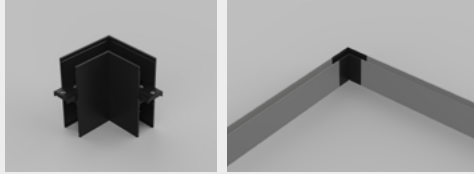
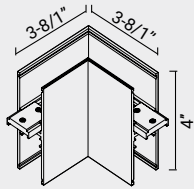

FG-SM-DI-ACC-5

"T" track Connector for Same Plane

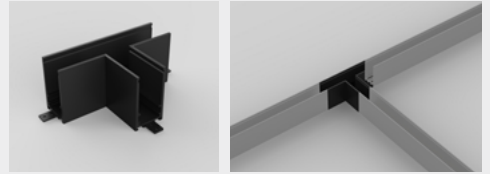
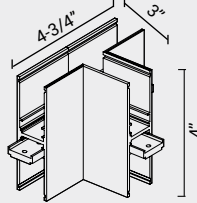

FG-SM-DI-ACC-3

"L" track Connector for inside corner of two surfaces

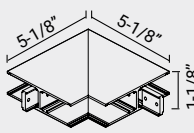

FG-SM-DI-ACC-6

"X" track Connector for inner corner of two surfaces

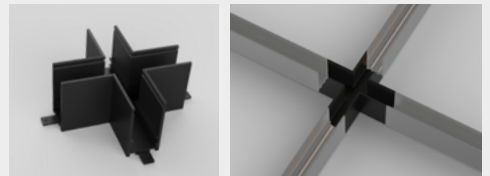
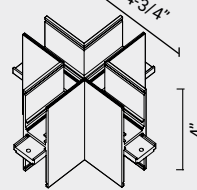

FG-SM-DI-ACC-4

"L" track Connector for outside corner of two surfaces

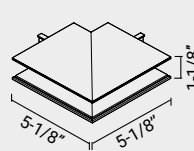

CORNERS EXAMPLE

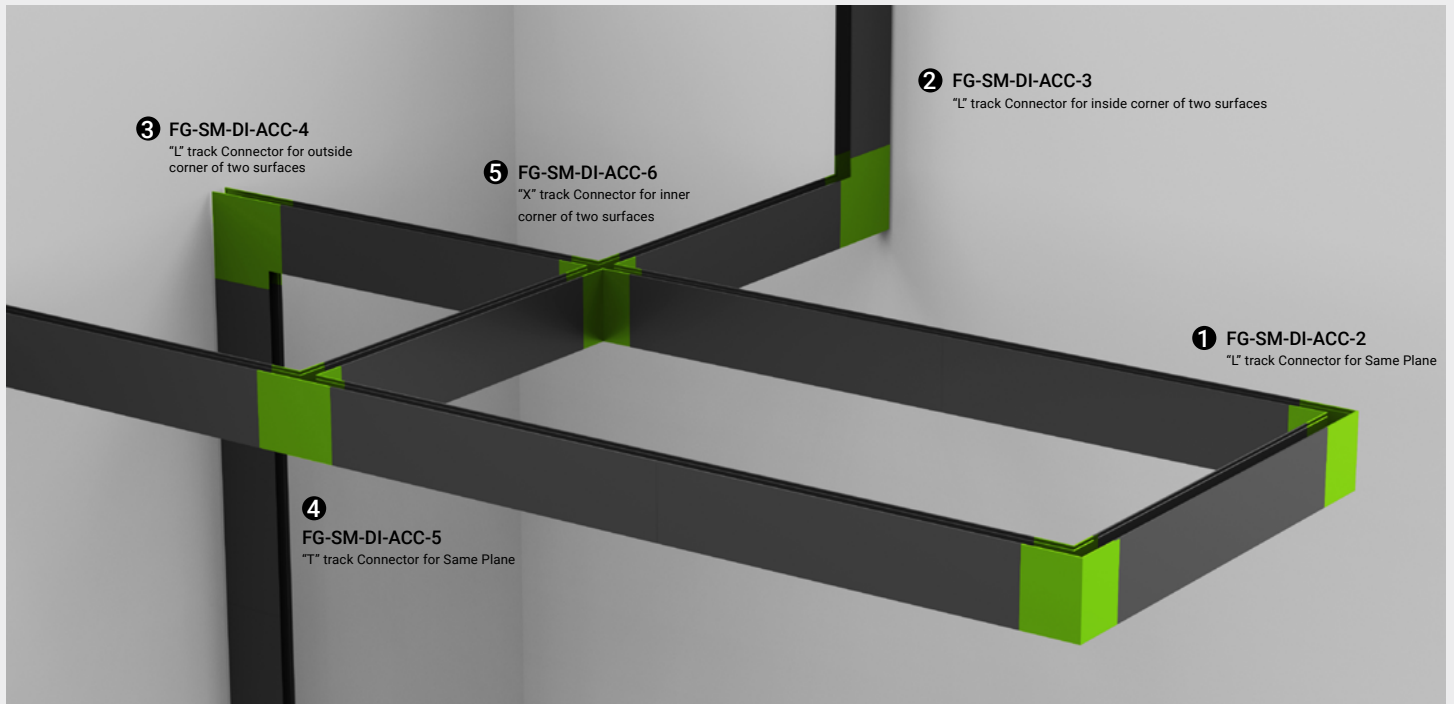

ACCESSORIES

● BK - (black) ○ WH - (white)

FG-ACC-1

Endcap (*2 for each DI track end)

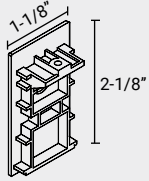

FG-ACC-2-2 (2')
FG-ACC-2-4 (4')
FG-ACC-2-8 (8')

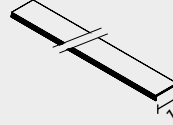

Track Cover Cap (to avoid dust or decorate)



FG-ACC-3

Live-end (for down track power feed)

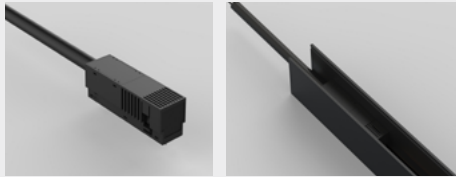
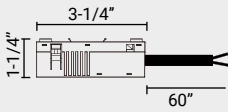

DO NOT SLIDE IT INTO THE TRACK.

FG-ACC-3-1C

Opposite Direction Live-end (for up track power feed)

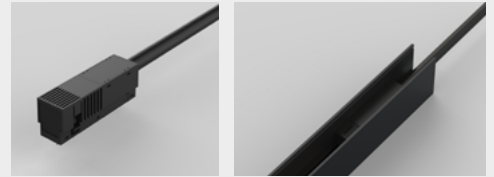
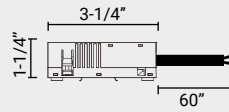

DO NOT SLIDE IT INTO THE TRACK.

FG-ACC-4

Power Connector (Between Straight Down Tracks)

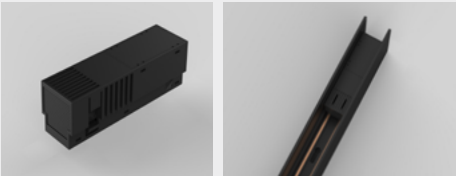
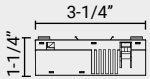

DO NOT SLIDE IT INTO THE TRACK.

FG-ACC-5

Power Connector (for Corners and Up Straight Tracks)

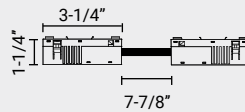

DO NOT SLIDE IT INTO THE TRACK.

FG-ACC-5-L

Power Connector for "T" Corners (flexible cable)

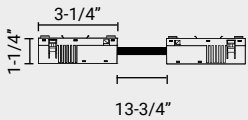

DO NOT SLIDE IT INTO THE TRACK.

FG-SM-DI-ACC-7

Adapter Cap (direction translator for FG-ACC-3/5)

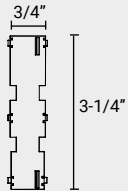

FG-SM-DI-ACC-9

Track Physical Connector

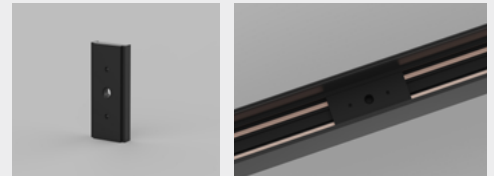
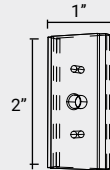

Hanging Wire

● BK - (black) ○ CH - (Chrome)

FG-SM-DI-ACC-1

Suspended Hanging Wire (60")

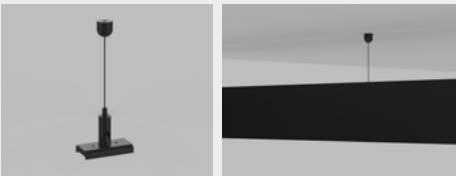
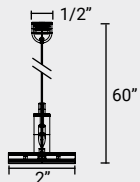

INTERNAL DRIVER OPTIONS (with box):

● BK - (black) ○ WH - (white)

Install the driver into ceiling or into the actual track with the following driver box options
*please be careful about the current direction when using the internal driver.

FG-DI-200W-ON-OFF-48V

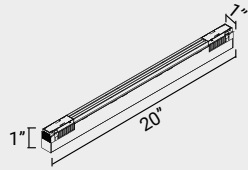

Voltage: 120V
Maximum Load: 200W
Dimming Option: Power ON/OFF

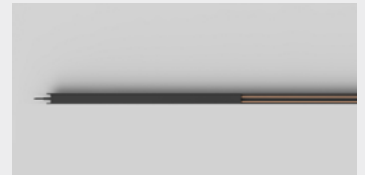
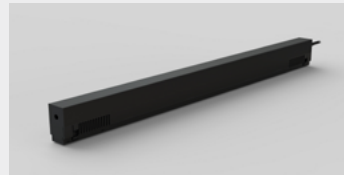

FG-DI-200W-10V-DIM-48V

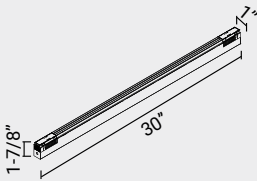

Voltage: 120V
Maximum Load: 200W
Dimming Option: 0-10V Dimmable

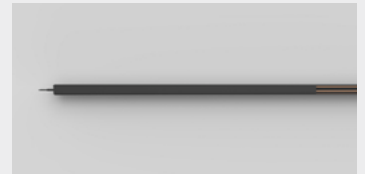
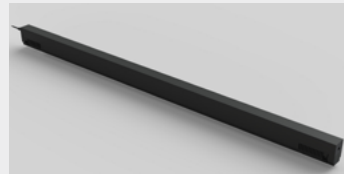

FG-DI-200W-DALI-48V

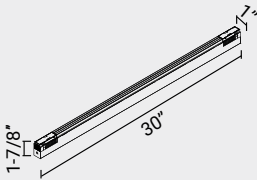

Voltage: 120V
Maximum Load: 200W
Dimming Option: Dali Dimmable

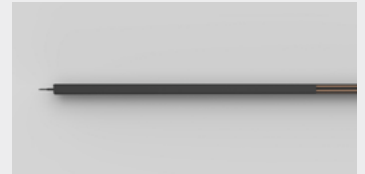
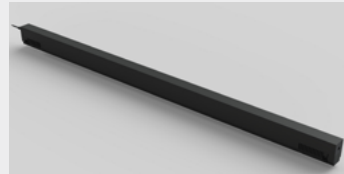

EXTERNAL DRIVER OPTIONS (with box):

FG-DR-75W-ON-OFF-48V | FG-DR-75W-10V-DIM-48V | FG-DR-75W-DALI-48V

FG-DR-75W-48V Series Constant Voltage + Constant Current Driver								
Model	Input Voltage	Output Voltage	Wattage (@120VAC)	Wattage (@277VAC)	Rated Current	Efficiency	Frequency	Power Factor (Normal)
FG-DR-75W-48V	120-277VAC 2	24-48V	60W	76.8W	1.6A	90%	50-60Hz	.9

0-10V & DALI dimming only

FG-DR-100W-ON-OFF-48V | FG-DR-100W-10V-DIM-48V | FG-DR-100W-DALI-48V

FG-DR-100W-48V Series Constant Voltage + Constant Current Driver								
Model	Input Voltage	Output Voltage	Wattage (@120VAC)	Wattage (@277VAC)	Rated Current	Efficiency	Frequency	Power Factor (Normal)
FG-DR-100W-48V	120-277VAC	24-48V	70W	96W	2A	90%	50-60Hz	.9

0-10V & DALI dimming only

EXTERNAL DRIVER OPTIONS:

FG-DR-150W-ON-OFF-48V | FG-DR-150W-10V-DIM-48V | FG-DR-150W-DALI-48V

FG-DR-150W-48V Series Constant Voltage + Constant Current Driver								
Model	Input Voltage	Output Voltage	Wattage * (@120VAC)	Wattage * (@277VAC)	Rated Current *	Efficiency *	Frequency	Power Factor (Normal)
FG-DR-150W-48V	120-277VAC	24-48V	105W	150W	3A	90%	50-60Hz	.9

0-10V & DALI dimming only
Type BE has different Wattage, Current & Efficiency See Chart Below

FG-DR-200W-ON-OFF-48V | FG-DR-200W-10V-DIM-48V | FG-DR-200W-DALI-48V

FG-DR-200W-48V Series Constant Voltage + Constant Current Driver								
Model	Input Voltage	Output Voltage	Wattage * (@120VAC)	Wattage * (@277VAC)	Rated Current *	Efficiency *	Frequency	Power Factor (Normal)
FG-DR-200W-48V	120-277VAC	24-48V	150W	200W	4.16A	93%	50-60Hz	.9

0-10V & DALI dimming only

FG-DR-320W-ON-OFF-48V | FG-DR-320W-10V-DIM-48V | FG-DR-320W-DALI-48V

FG-DR-320W-48V Series Constant Voltage + Constant Current Driver								
Model	Input Voltage	Output Voltage	Wattage * (@120VAC)	Wattage * (@277VAC)	Rated Current *	Efficiency *	Frequency	Power Factor (Normal)
FG-DR-320W-48V	120-277VAC	24-48V	320W	320W	6A	95%	50-60Hz	.9

0-10V & DALI dimming only

FG-DR-480W-ON-OFF-48V | FG-DR-480W-10V-DIM-48V | FG-DR-480W-DALI-48V

FG-DR-480W-48V Series Constant Voltage + Constant Current Driver								
Model	Input Voltage	Output Voltage	Wattage * (@120VAC)	Wattage * (@277VAC)	Rated Current *	Efficiency *	Frequency	Power Factor (Normal)
FG-DR-480W-48V	120-277VAC	24-48V	480W	480W	10A	94%	50-60Hz	.9

0-10V & DALI dimming only

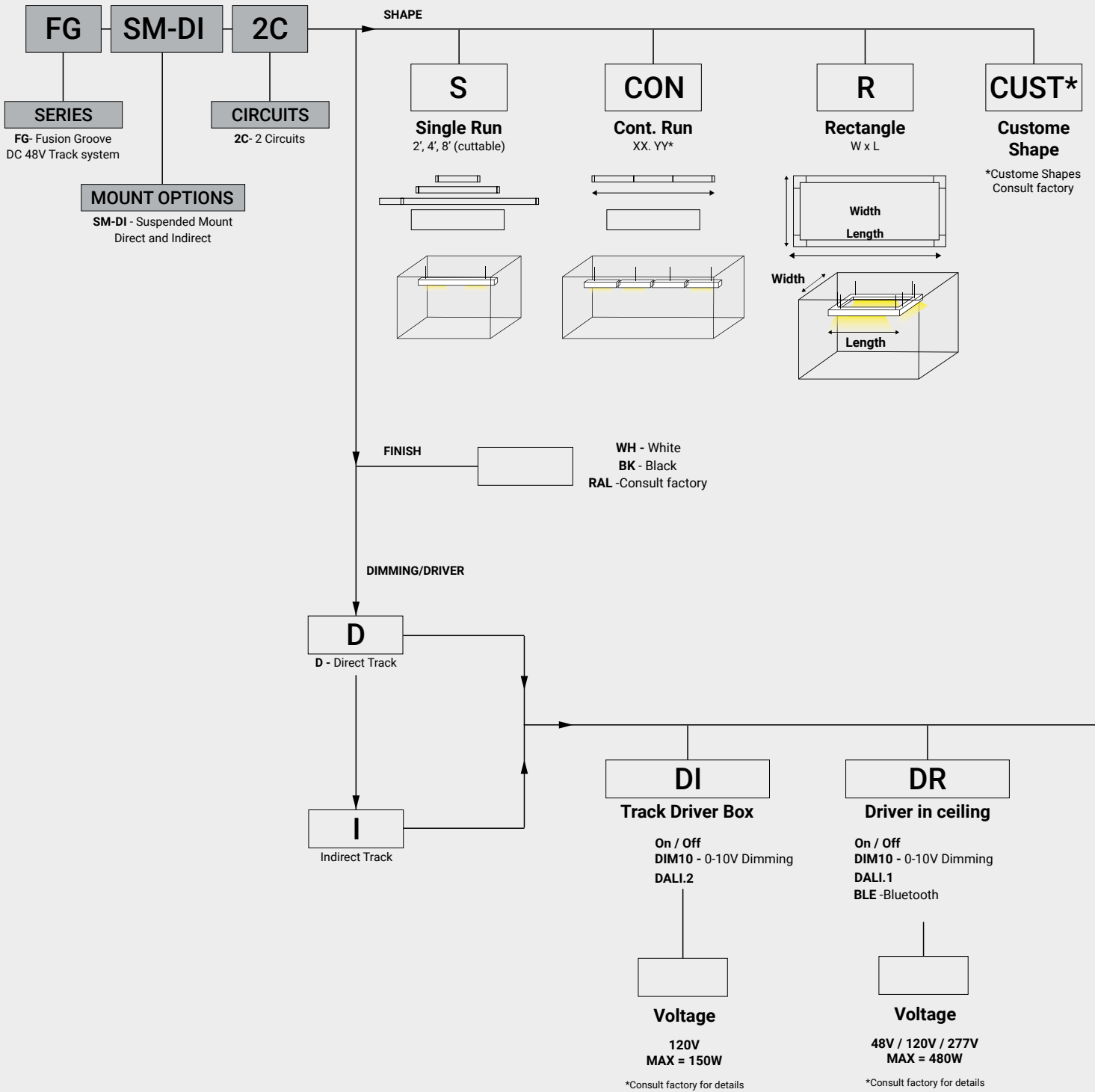

Typical Configuration Design Examples:

**These examples are for the concept understanding, please consult order@iuseelite.com for customize service.*

FG-SM-DI-2C-S-BK-D-DR-DIM10-I-DR-DIM10

E.g. 1: Groove Suspended Mount Direct/Indirect 8' track 2-circuit in black with 150W 0-10V dimming remote drivers:

Keywords: 2 Circuits / Single / Remote Drivers

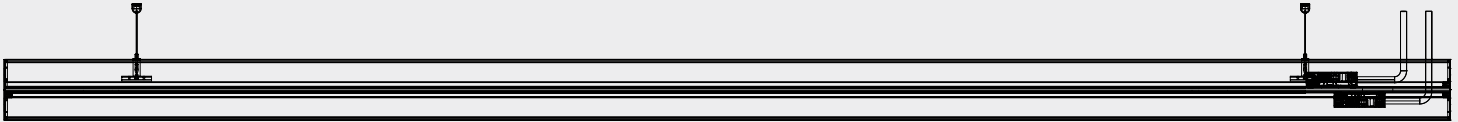

Part Number	Quantity	Description	Category
FG-SM-DI-A-8-BK	1	8' FG-SM-DI A Track in Black	Track
FG-ACC-1-BK	4	Endcaps	
FG-SM-DI-ACC-1-BK	2	Suspended Hanging Wire in Black	Mounting
FG-ACC-3-BK	1	Live End (power connector from the driver to the down track)	Power Accessory
FG-ACC-3-1C-BK	1	Live End Opposite Direction (power connector from the driver to the up track)	
FG-DR-150W-10V-DIM-48V	2	150W 0-10V Dimming Remote Driver	Driver

**Take the included power connector off from the A track.*

FG-SM-DI-2C-CON-4.4-BK-D-DR-DIM10-I-DR-DIM10

E.g. 2: Groove Suspended Mount Direct/Indirect Continuous 8' track in black with 2 circuit 150W 0-10V dimming remote driver:

Keywords: 2 Circuits / Continuous 4'+4' / Remote Drivers



FG-SM-DI-B-4

FG-SM-DI-A-4

Part Number	Quantity	Description	Category
FG-SM-DI-A-4-BK	1	4' FG-SM-DI A Track in Black	Track
FG-SM-DI-B-4-BK	1	4' FG-SM-DI B Track in Black	
FG-ACC-1-BK	4	Endcaps	
FG-SM-DI-ACC-1-BK	2	Suspended Hanging Wire in Black	Mounting
FG-ACC-4-BK	1	Power Connector (between straight down tracks) in Black	Track Connection
FG-ACC-5-BK	1	Power Connector (for corners and up straight tracks) in Black	
FG-SM-DI-ACC-9	1	Track Physical Connector	
FG-ACC-3-1C-BK	1	Live End Opposite Direction (power connector from the driver to the up track)	Power Accessory
FG-ACC-3-BK	1	Live End (power connector from the driver to the down track)	
FG-DR-200W-10V-DIM-48V	2	200W 0-10V Dimming Remote Driver	Driver

**Take the included power connector off from the A track.*

Typical Configuration Design Examples:

*These examples are for the concept understanding, please consult order@iuseelite.com for customize service.

E.g. 5: Groove Suspended Mount Direct/Indirect 4'x4' Rectangle in black with 2 circuit 320W 0-10V dimming remote driver:

FG-SM-DI-R-4X4-BK-2C-D-DR-DIM10-I-DR-DIM10

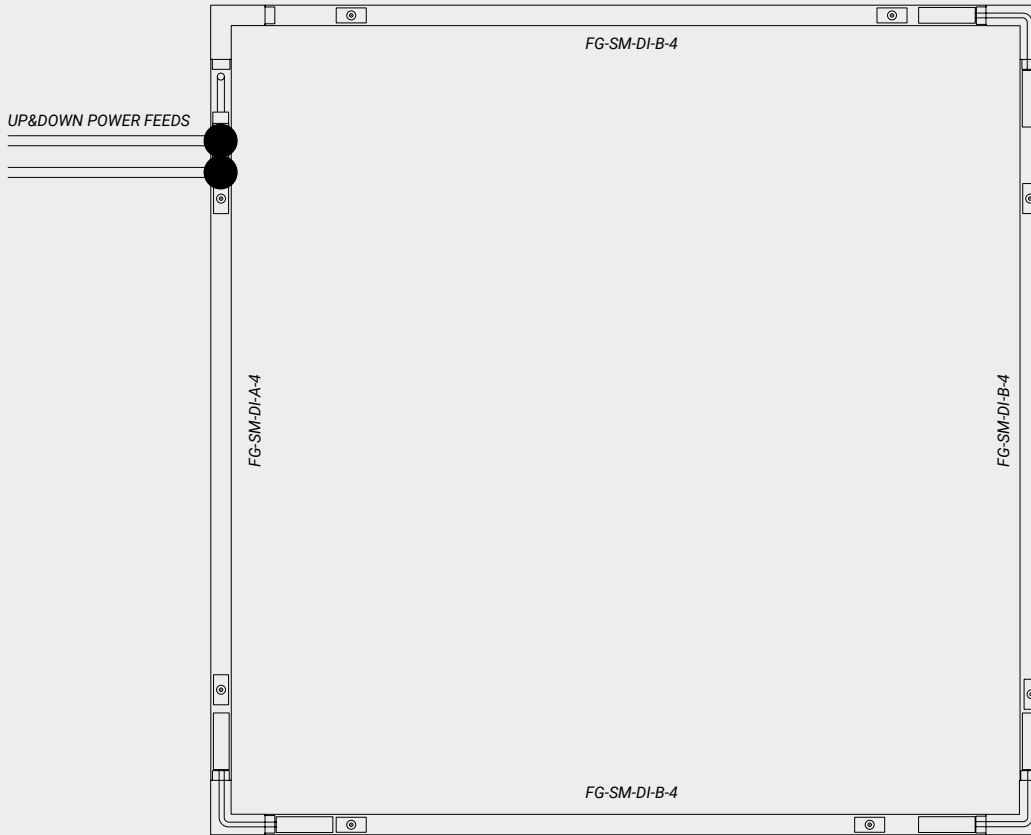

Part Number	Quantity	Description	Category
FG-SM-DI-A-4-BK	1	4' FG-SM-DI A Track in Black	Track
FG-SM-DI-B-4-BK	3	4' FG-SM-DI B Track in Black	
FG-SM-DI-ACC-2-BK	4	"L" Track Corner Connector for Same Plane in Black	Corner
FG-SM-DI-ACC-1-BK	8	Suspended Hanging Wire in Black	Mounting
FG-ACC-5-BK	6	Power Connector (for corners and up straight tracks) in Black	Power Accessory
FG-ACC-3-1C-BK	1	Live End Opposite Direction (power connector from the driver to the up track)	
FG-ACC-3-BK	1	Live End (power connector from the driver to the down track)	
FG-DR-320W-10V-DIM-48V	2	320W 0-10V Dimming Remote Driver	Driver

*Take the included power connector off from the A track.

LIGHT MODULE EXAMPLES

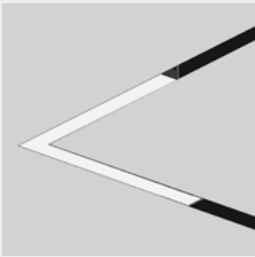

Seamless Linear Diffused
Corners
FG-L1R-C90 / CI / CO

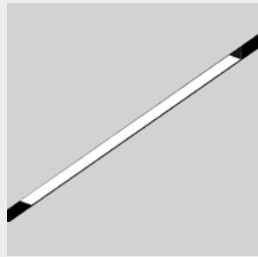

Seamless Linear Diffused
FG-L1R-8 / 16 / 32 / 48 / 64

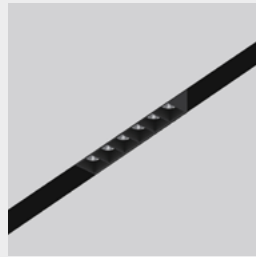

Linear Downlight
FG-L4R-3 / 5 / 8 / 16 / 32

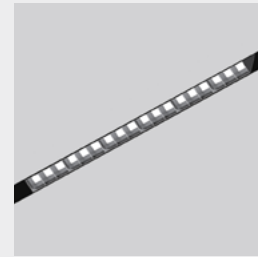

Linear Louvered
FG-L3R-16 / 32

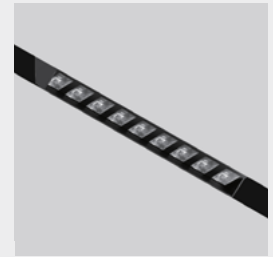

Wall Wash
FG-L1-WW-3 / 8



Linear Diffused & Adjustable
Light
FG-L2A-3 / 5 / 8

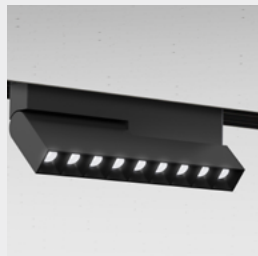

Linear Adjustable Downlight,
Task & Wall Grazer
FG-L4A-3 / 5 / 8



Recessed Track Light
FG-T1-1

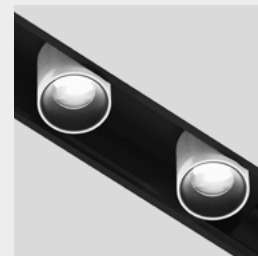

Recessed Track Light
FG-T1-2



Cylinder
FG-T2-1 / 2 / 3

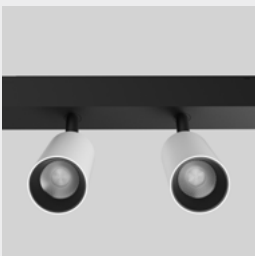

Cylinder
FG-T2-4

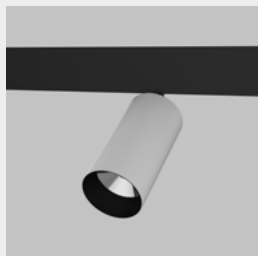

Cylinder
FG-T3-1 / 2 / 3



Beam Adjustable Cylinder
FG-T4-1 / 2 / 3



Projector
FG-TPJ-1



Gobo Projector
FG-TPJ-2



Flat Round
FG-T5-1 / 2



Flat Square
FG-T6-1 / 2



Rectangle Track Light
FG-T7-2

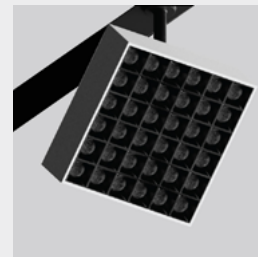

Square Track Light
FG-T7-1 / 3

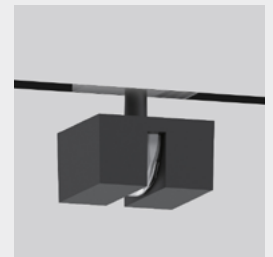

Line Light
FG-LL-1

LIGHT MODULE EXAMPLES



Wall Light
FG-WL-1



Wall Light
FG-WL-2

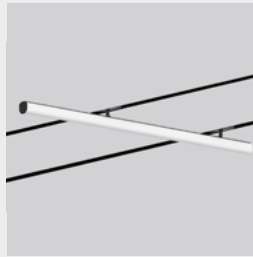

Linear Surface Light
FG-L5S-32 / 48



Linear Surface Light
FG-L2S-32 / 48

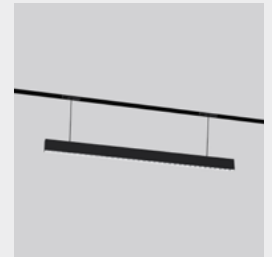

Pendant Louvered
FG-L1P-32



Pendant
FG-P1-1 / 2



Pendant
FG-P3-1 / 2

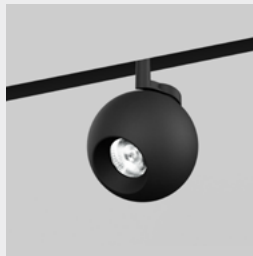

Track Globe
FG-T8-1



Track Globe
FG-T9-1



Track Downlight
FG-T10-1



Pendant Globe
FG-P4-1



Pendant Globe
FG-P4-2

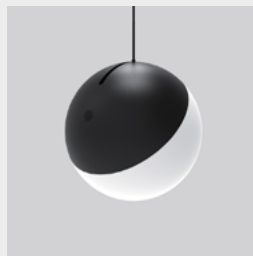

Pendant Globe
FG-P4-3



Globe
FG-T11-1



Globe
FG-P5-1